

Prestige

BI-FOLDING DOOR

Installation Guide



PART L Compliant ✓

 **SHEERLINE**[®]
ALUMINIUM WINDOWS AND DOORS

Contents

p3 Survey

Survey & Pre-Installation	3
---------------------------	---

p4 Bi-folding Door Installation

Fit Cill	4
Fit Frame	5
Roller Adjustment	6
Hinge Adjustment	6
Glazing	7
Toe & Heeling	8
Magnet Positions	9
Lock Adjustment	10
External Finishing & Final Checks	10

p11 Optional

Sash Removal	11
Installing Sashes	12
Frame Assembly & Corner Joint Adjustment	13
Fit Door Restrictor	14
Bead Removal	15
Frame Extenders	15
Operation	16

Survey & Pre-Installation

Check the aperture to make sure there is no loose plaster or brickwork, and that it is free of any debris or brick dust. Ensure that a solid, level base is present at the required dimensions and can provide packing points at 250mm centres and fixing points at 600mm centres.

Ensure floor levels do not obstruct door operation or impede drainage.

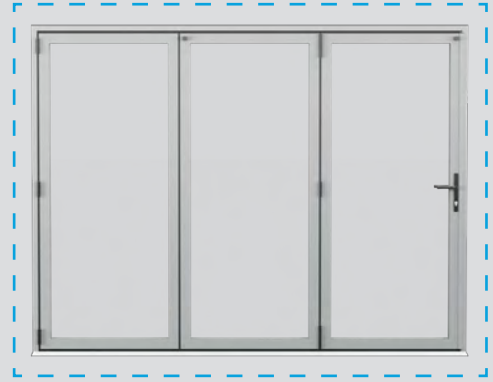

1.

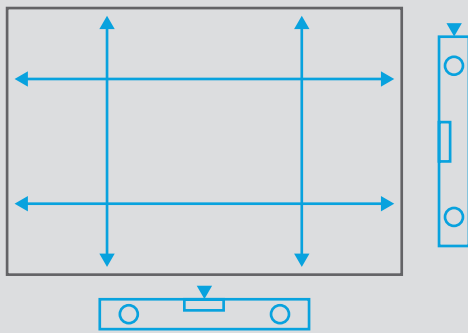

Ensure that all four sides of the aperture are plumb and square and identify any potential packing points. *Please note our recommended fixing positions are into the outer wall and the frames are not fixed over an open cavity as this can compromise system performance.*

2.

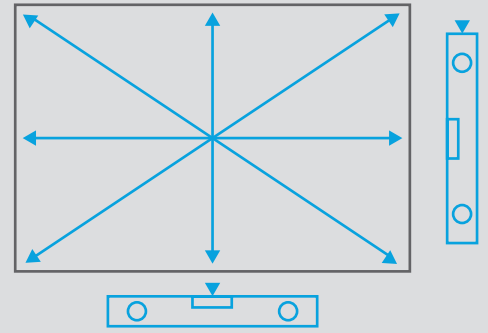

Ensure an adequate lintel or head linings are present, and are level and capable of supporting both the construction above and the bifold itself.

Note: The bifold should be packed under the jambs to provide sufficient support.

Check for alignment at points shown.

Frame size = brick-to-brick size – 5mm each side, to allow for level and square installation.

Disclaimer: Please check with the latest Building Regulations and standards that are relevant to your area for guidance and to ensure you comply with the latest regulations. The advice given in this document assumes fitting will be carried out by a qualified professional following BS 8213 - 4:2016 the Code of Practice for the Survey and Installation of Windows and External doorsets, where applicable.

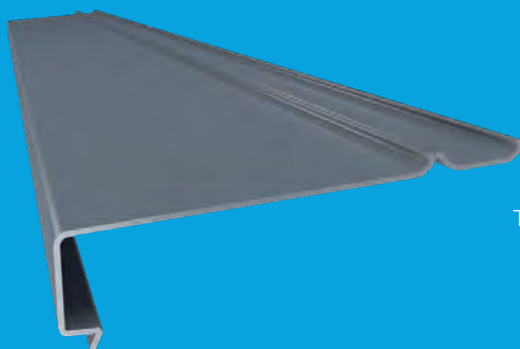

Cill Protector

SA516 Reusable Cill Protectors are available from Sheerline. These help prevent damage on renovations and new-builds where building work will continue after the bi-folds have been installed.

Fit Cill (If required)

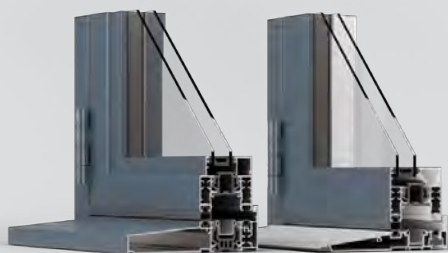

If your bi-fold is supplied with an integral or ramped threshold instead of a separate cill, still follow these instructions to ensure a level and weathertight installation.

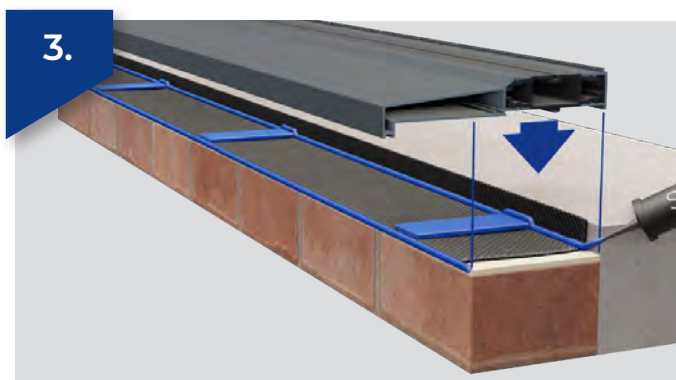

3. Add a damp-proof layer to prevent water ingress, running this 150mm up either side of the aperture. This needs integrating correctly with the structures original damp proof course. Ensure the cill is level and sufficiently packed to support the bi-fold along its full width. If the surface is uneven then a mortar bed may be necessary. If a mortar bed is not required then seal along edge using silicone sealant as shown.

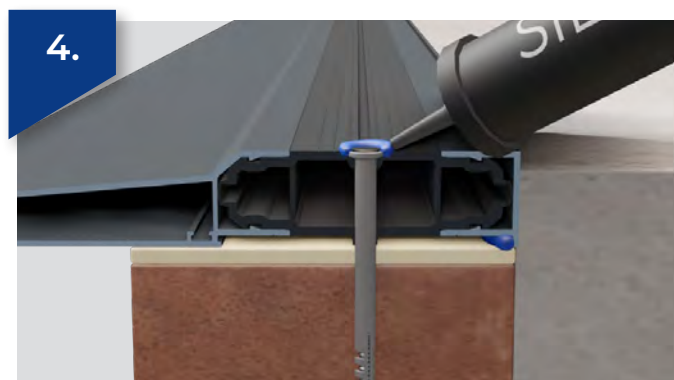

4. Once you have positioned the cill and made sure it's level, drill & fit through the centre of the thermal break as shown above, using suitable fixings, at the positions shown in point 5 below. Applying a small amount of silicone to fixings to prevent water ingress.

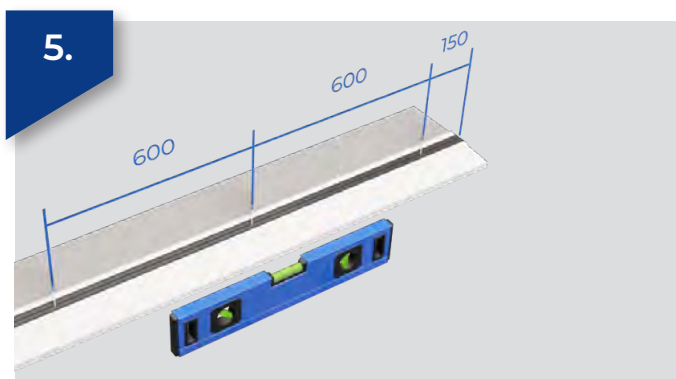

5. Fix 150mm from each end, and no more than 600mm between centres. Use a 1.8m level, laser level or suitable device to ensure the cill is level (+/-1mm per metre).



6. Once the cill is fitted apply a bead of silicone sealant at each end of the cill and along the inner edge of the upstand.

Fit Frame

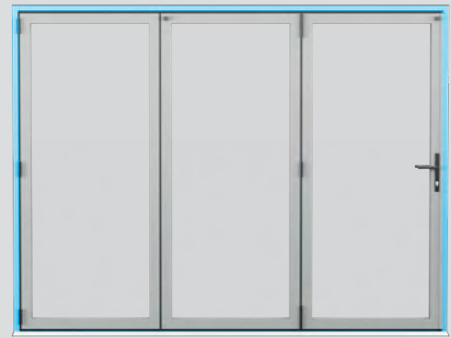

7.



Position frame (along with any optional integral cill or low threshold) into the opening ensuring it's square and plumb, and pack accordingly using frame packers. Also check diagonals are within +/- 1mm. Open doors and support the sashes. Alternatively sashes can be removed as shown on page 11.

8.



Drill and fix the frame at 150mm from each end, and no more than 600mm between centres. Fit packers at the same locations. Ensuring the head of screws are below the bottom of the track, to prevent the rollers colliding. Sealing the bottom fixing locations to prevent water ingress. Please note points 9 and 10 for side fixings.

9.



Remove side cover trim before fixing through the centre of the thermal break as shown.

10.



Once fixings are in place, reinstall the cover trim as shown.

11.



Finally check alignment of frame.

Roller Adjustment & Hinge Adjustment



Rollers should require minimal adjustment.

12.



Double roller

Loosen the two grub screws using a 2.5mm Allen key prior to adjusting and retighten once adjustment has been made. Adjust roller using a 6mm Allen key so that an equal gap of 12mm +/-1mm is maintained above and below between frame and sash. Clockwise = downwards adjustment. Anticlockwise = upwards adjustment.

13.

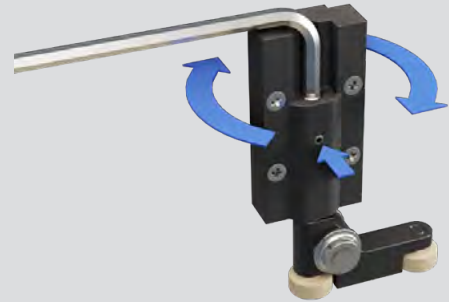

Single roller

Loosen grub screw using a 2mm Allen key prior to adjustment and retighten when adjusted. Adjust roller using a 4mm Allen key so that an equal gap of 12mm +/-1mm is maintained above and below between frame and sash. Clockwise = upwards adjustment. Anticlockwise = downwards adjustment. *NB. This is different from double roller.*

14.



Hinge adjustment packers are available if required to square up the sashes in the frame, and each packer gives you 0.5mm of adjustment. Note: Maximum of 2 packers per hinge. Fit the necessary packers prior to fitting the hinge.

15.



Fit final fixing screws in hinges once all adjustments have been made.

Glazing

Remove beads carefully and place them to one side to ensure they can be returned to their original positions in the correct order.

Ensure all gaskets are inserted into each bead before glazing.

Install the glazed unit and pack as shown using 3-4mm glazing packers (sizes may vary due to glass and door manufacturing tolerances).

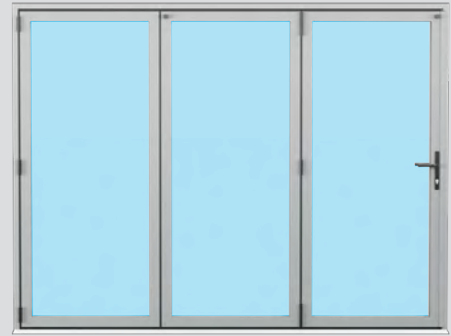

16.

Toe & Heel



Pack square*



17.

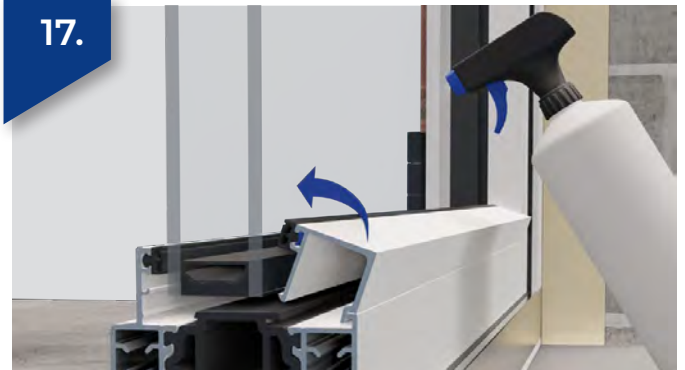

Glazing platforms

SM123 used for contemporary sash

SM125 used for stepped sash

Both available from Sheerline

*Additional packers may be required on taller doors where there is an additional locking point.

Refer to page 8 for Toe & Heel instructions by door style

We advise spraying the unit with a mild soap/water mixture or glass cleaner to make beading easier. Ensure you have toe & heeled/packed the unit correctly as shown on page 8. Fit the top bead in place to secure the glazed unit (rotating the beads until they clip in to place as shown above). Next, fit the bottom bead.

18.



Next, fit the two vertical beads, being careful not to scratch the painted profile while fitting. Finally run your finger along the gasket edge to check they have seated correctly, adjusting if required.

Toe & Heeling

Please Toe & Heel the bi-fold according to the configuration specific packing diagrams below to ensure correct operation.

Toe & Heel

Pack square*



Glazing Platforms

SM123 used for contemporary sash
 SM125 used for stepped sash
 Both available from Sheerline
 *Additional packers may be required on taller doors where there is an additional locking point.

Magnet positions

● 26mm Magnets ■ 65mm Magnets

1-1-0

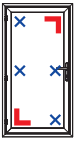

2-1-1

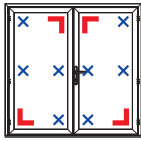

2-2-0

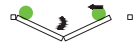
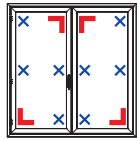

3-2-1

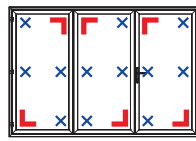

3-3-0

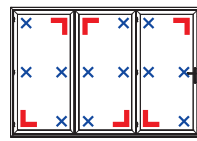

4-3-1

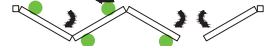
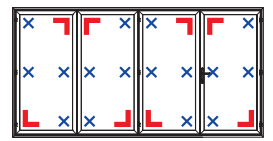

4-4-0

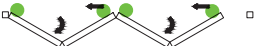
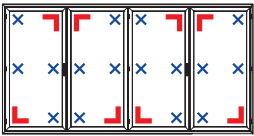

4-2-2

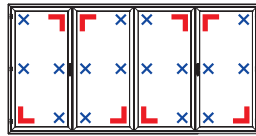

5-4-1

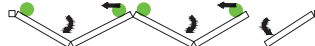
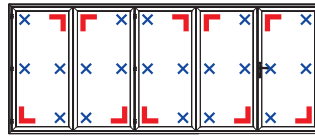

5-5-0

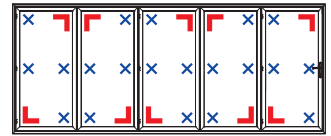

5-3-2

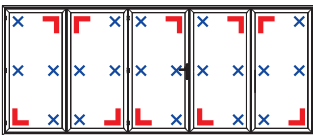

6-5-1

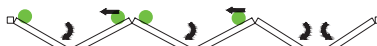
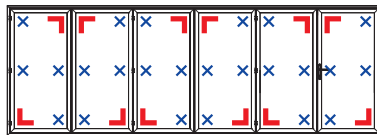

6-6-0

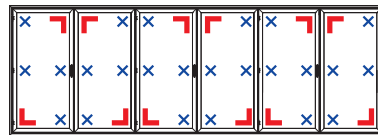

6-4-2

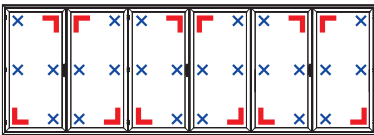

6-3-3

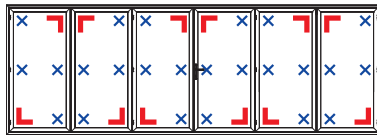

7-6-1

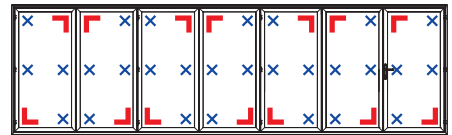

7-7-0

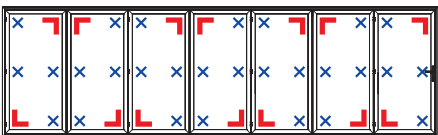

7-4-3

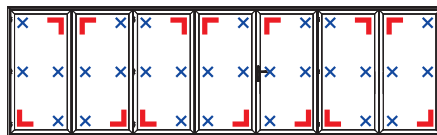

7-5-2

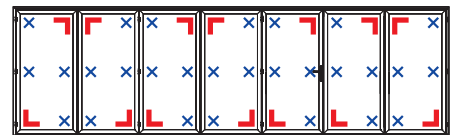

Magnet Positions

Magnets may arrive pre-fitted or may need to be fitted on site. Position the relative magnet on each opposing sash and fix into place using 4.3x25 countersunk screws. Please note all dimensions are from the outer edge of the sash.

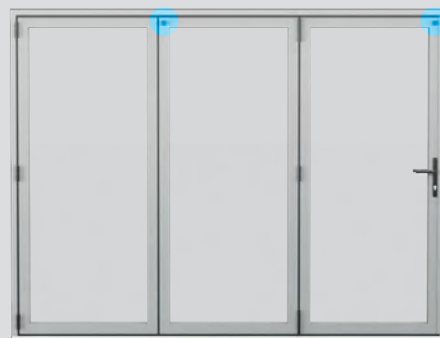

Magnets come in 2 sizes, 26mm and 65mm, page 8 shows the correct placement for each door configuration.

19.

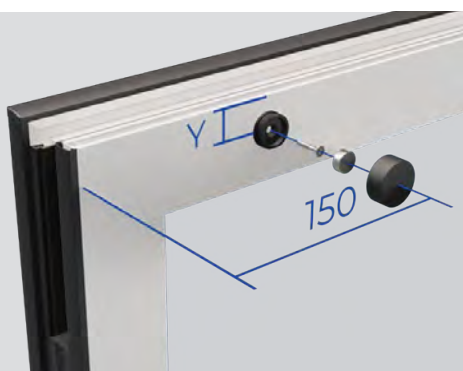

These magnet positions below are for regular width doors with **double rollers**. Fix 150mm in from edge of the sash. For vertical positioning please see point 22 below.

20.



These magnet positions below are for doors with **single rollers**. Fix 207mm in from edge of the sash. For vertical positioning please see point 22 below.

21.

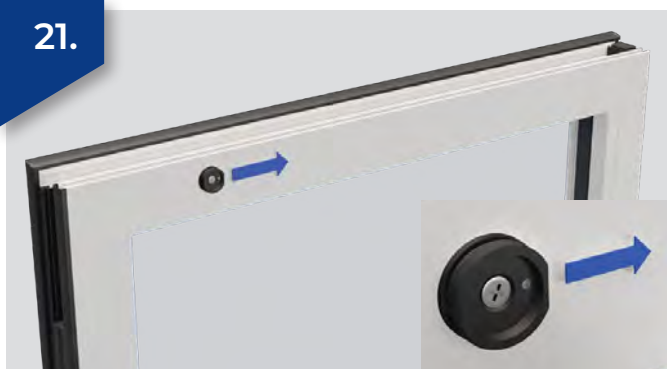

Base plate orientation

Ensure base plate is positioned so the anti-rotation grub screw is pointed towards the opposite hinge side.

22.

Dimension Y

To find the correct fixing position from the top of the door sash check the chart below.

Externally opening doors

Dimension Y = 23mm (on external face)
31mm (on internal face)

Internally opening doors

Dimension Y = 31mm (on external face)
23mm (on internal face)

Lock Adjustment

Please ensure door frame and sashes are correctly packed prior to lock adjustment.



23.



Latch plate adjustment

If the door will not close properly you can adjust the latch using the two screws in the diagram using a Phillips screwdriver.

24.



Hook keep adjustment

The keeps can be adjusted using a T15 driver. This will ensure smooth operation and good compression, preventing drafts and ensuring a good weather-tight seal.

External Finishing & Final Checks



25.

Break off any protruding packers where necessary.

26.

Remove protective tape from all profiles. Clean down aluminium and glass with warm, soapy water.

27.

An expanding foam can be used to fill any large apertures around the frame. Be careful not to overfill. Now trim or silicone around outer frame and seal below external cill if applicable.

28.

Check the bi-folding door for correct function, and instruct the homeowner on their correct operation.

Optional

Sash Removal

Prestige bi-folds are supplied with the sashes already hinged and screwed into position (unless otherwise requested). We recommend removing the sashes prior to installation to make fitting easier.

The following is based on a 330 bi-fold, but the same procedure applies to other configurations.

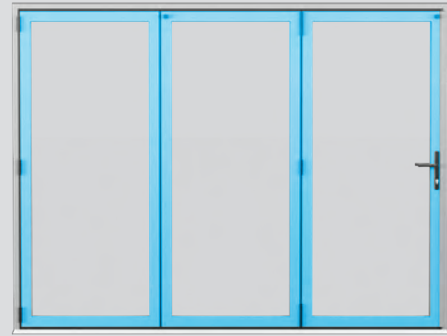

29.



Starting with the single 'traffic' sash if available. Open and remove the screws from the hinges, fully supporting the sash while this is done. Lift carefully and place securely out of the way to prevent damage.

30.



For track bound doors release the espag handle and slide the doors towards the hinged jamb until the central hinges are exposed. Remove the screws and remove the sash by supporting at the hinged jamb and sliding away from the hinged sash. This can then be removed by angling the sash until the top guide disengages from the track. Carefully lift the sash out of the bottom track until the roller is clear and place securely out of the way to prevent damage.

31.



The final sash can be removed from the hinges by removing the three screws in each hinge as before, fully supporting the sash while this is done. Lift carefully and place securely out of the way to prevent damage.

Optional

Installing Sashes

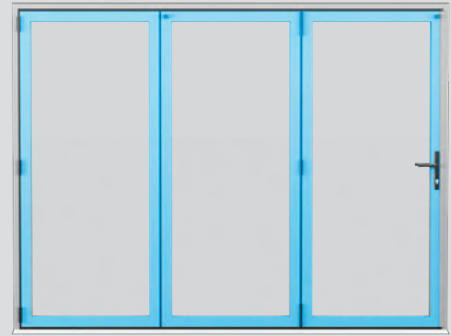

32.



Sash 1 (hinged to outer frame)

Locate the first sash on the hinged outer frame jamb and fit two M5 x 10mm machine screws into each hinge, semi-tightening in position. Once satisfied with the alignment of the door in open and closed positions tighten the M5 screws securely and insert the final 3.9 x 25mm countersunk hinge location screws.

33.



Sash 2 (including rollers)

With the first sash remaining open insert the second sash and locate the roller in the bottom stainless steel track. Leaning the sash away from the first, locate the top roller into the top track and secure to the previous sash using the M5 x 10mm screws as before (ensuring any pull handles are in the correct position). Once satisfied with alignment, tighten the M5 screws and insert the final 3.9 x 25mm countersunk centre location screws.

34.



Single doors

When fitting single 'traffic' doors, make sure the other sashes are closed and secured with shoot bolts. Fix using M5 x 10mm machine screws and check for alignment as before, then tighten the M5 screws and insert the final 3.9 x 25mm countersunk centre screws.

Optional

Frame Assembly (Kit Form) & Corner Joint Adjustment

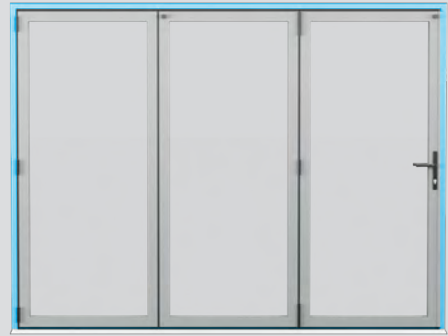

35.

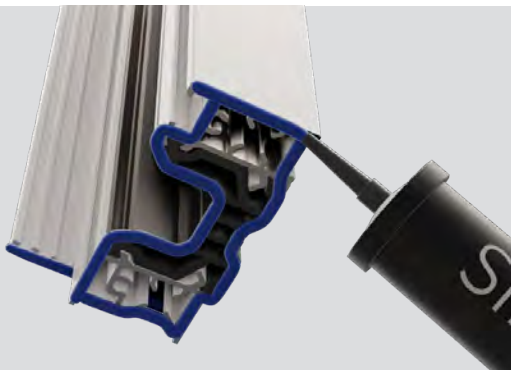

Run a continuous bead of silicone sealant around the joint between the end-milled frame and the threshold.

36.



Secure the frame to the threshold using the supplied 4.8 x 55mm screws through the pre-drilled holes. Secure the top of the outerframe using the same method.

37.

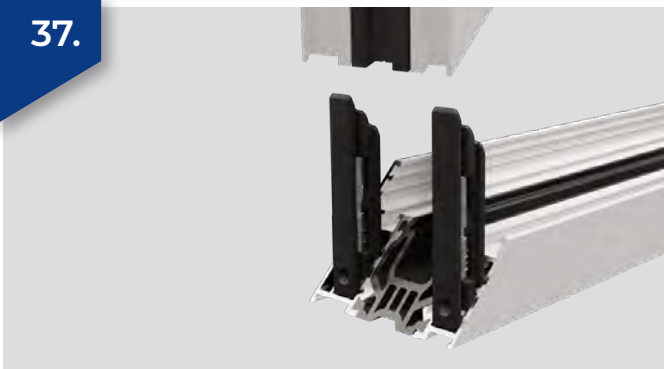

Mitred corners are constructed using 2 corner cleats that fit into locating channels in the aluminium profiles. First fit the cleats into one length of profile using a T25 Torx driver. The Torx driver fits through the pre-drilled holes as shown right. Tightening the fitting will draw the corner cleat into place. Fit the next length to form a corner using the same method.

38.

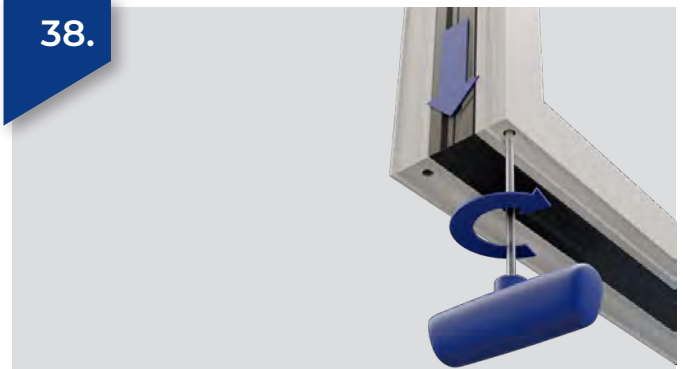

Fine adjustment of the corner joint can be done with a hand-held T25 Torx driver. Turning the cleat screw in a clockwise direction will draw the opposing profile toward you. It is important not to overtighten too much. We also advise gradually working on each cleat in turn to avoid stressing the corner cleat.

Optional

Fit Door Restrictor

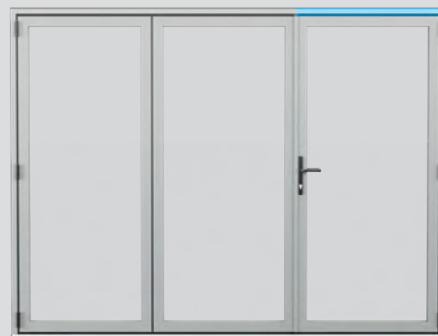

39. Locate datum bar against sash insert and screw the door restrictor into position on the sash using four 4.3 x 25mm countersunk screws.



40. Slide & click the guide into position at the hinge end of the sash head.

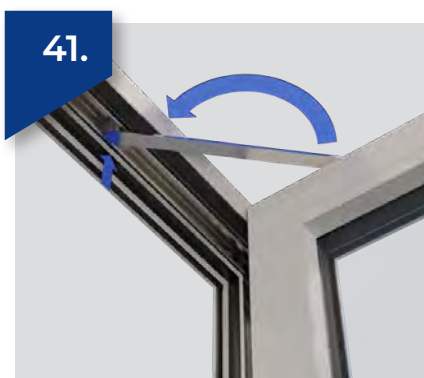

41. Open the sash to desired maximum opening angle, hold or wedge to keep it in place, and then position the restrictor arm to determine frame bracket location.

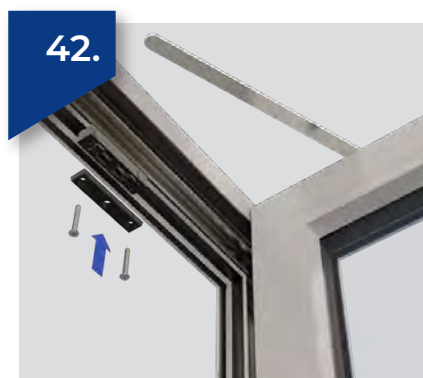

42. Mark & drill two 2.5mm pilot holes through the head track & fit the frame bracket and track location packer with two 3.9 x 30mm countersunk screws.



43. Connect restrictor arm to frame bracket assembly. Then test for correct function.

Optional

Bead Removal

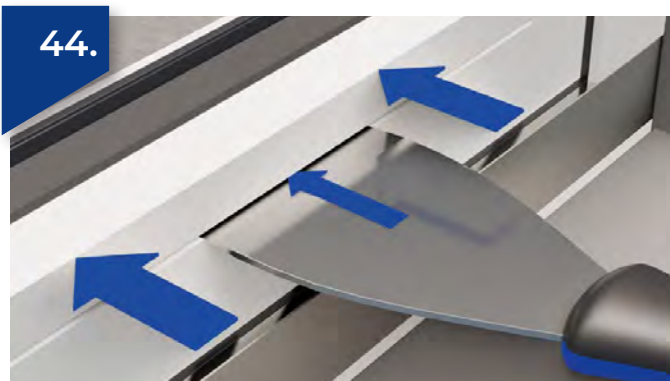

44. Push on upper edge of bead to tilt it backwards to allow you to slide a tool between the bead and sash profile.



45. Push down on tool to disengage bead.

Frame Extenders

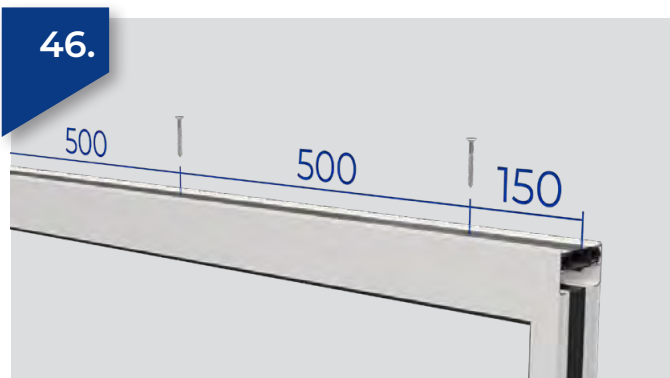
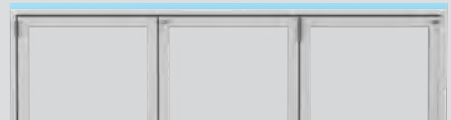

46. Fix frame extender 150mm from ends and max 500mm between centres using 4.3 x 55mm countersunk screws (or 4.3 x 35mm countersunk screws if the extender is flipped with the thermal break against the frame)

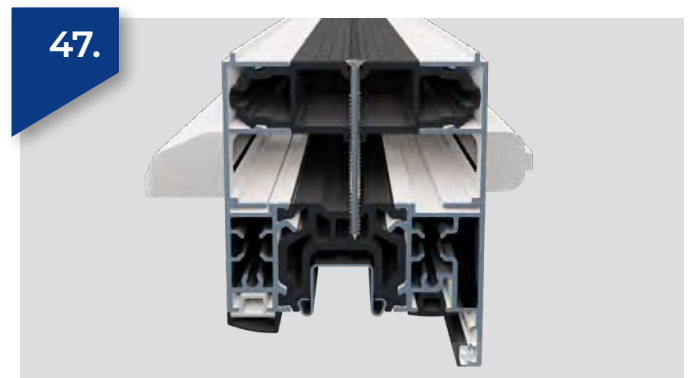

47. Fix as above to ensure the screws will not break through into the bi-fold track.

Bi-Folding Door Operation



***PLEASE NOTE:** *Bi-folding doors should not be operated by young children.*

1. Operation



To avoid mishandling, always fold back each door sash fully before opening the next section*

2.



Ensure doors are held in place via the magnets when open

www.sheerline.com