

# PORTFOLIO



whiteline<sup>®</sup>

THE COMPLETE FENESTRATION COMPANY

# strategy performance

## RESULTS



## Innovating since 1984

Established in 1984, we are the largest independent fabricator of PVCu and Aluminium windows and doors in the South East.

From our factory in Eastbourne we supply and support our customers throughout London, the South East and beyond.

## What we do?

We work with our customers, in partnership, delivering the right British made products, services and support to grow their business.

Listening, learning and understanding how we can actively help them to succeed.

## Why use us?

Are you looking for a different type of supplier that can deliver a different type of relationship?

A full range of energy efficient windows, conservatories, doors and accessories? Market leading specifications and the PlatinumNRG brand to promote them? A partnership team ready to work with you into the future? Welcome to Whiteline.

## The Present

We care passionately about our customers, staff, and the environment. We strive for continuous improvement in our operations and with our suppliers, so we can deliver the products, services and support that you need.

We offer a fantastic PVCu range, such as our unique **slimSASH** and **flushSASH** range as well as **sculpturedSASH** and **chamferedSASH** windows and doors.

In addition to PVCu, we also offer an extensive range of Aluminium windows and doors, including the revolutionary Sheerline windows, to meet the needs of your customers.

## The Future

We are committed to innovation and improvement of our product and service offerings.

We have the technology to deliver products that match the most demanding energy standards, like A+ rating and PassivHaus, that customers will increasingly demand.

We will be making it easier for you to sell and deliver to them, with real time design, web ordering and delivery scanning technology, making transactions faster and business less work.



## Helping you

Starting with our products - we've ensured that we have window and door systems suited to every property type in the UK. All of our products can be tailored towards individual requirements in terms of aesthetics, security and insulation.

For consumer confidence, we have accreditations for all of our products and can supply certification where necessary.

Logistically, we have an extensive vehicle fleet to deliver across a large part of southern and eastern England.

All deliveries are tracked and monitored with advance notice of arrival.

In-house, we offer full technical support on every aspect of construction and application.

We have a dedicated Customer Services department to look after you and form your point of contact within the company.

Our dedicated Processing Team handle quotations and process orders based on the information supplied to them.

Our expanding on-line services range from offering your own website, bespoke brochures, downloadable PDF brochures to name just a few.

# environmental

## materials, manufacture and sustainability



### PVCu

With environmental issues being at the forefront of today's media it is very easy to confuse modern PVCu windows with the damaging, non-degradable plastics so abundant in everyday life.

#### **IT'S NOT PLASTIC!**

uPVC (unplasticised PolyVinyl Chloride) was the term used in Britain before the name was changed to PVCu in the late 1980s to fall in line with the rest of Europe. However, many people assume that uPVC and PVCu refers to different materials - they are exactly the same!



#### **NON-POISONOUS**

Differences do occur within the PVCu itself by way of stabilisers - many companies have used lead whereas we have only used calcium. Therefore the material itself is non-poisonous in use and during recycling.

#### **RECYCLABILITY**

PVCu windows use less energy to produce in a factory in comparison to both aluminium and timber windows. Our PVCu window is 100% recyclable and can be recycled up to 10 times, giving each window an estimated life span of 350 years!



#### **ENVIRONMENTAL IMPACT**

The material itself, its reduced manufacturing and recycling costs and long term product-life leave a small carbon foot print whilst the ongoing energy savings are higher, with more PVCu windows achieving BFRC 'A' ratings than other materials.

## ALUMINIUM

Aluminium is known for being lightweight, durable, and low maintenance, while also aiding the high performance of our systems due to its immunity to UV, low conductivity, and fire resistance.

#### **RECYCLABILITY**

Up to 90% of all aluminium used in construction is recycled, using 95% less energy to manufacture than its primary production - with no deterioration in quality.

Aluminium does not age like other organic materials and needs no protection from ultra-violet light. Its overall life-cycle is more environmentally friendly due to the minimum energy required in maintenance and the well-established, proven design life of aluminium assures that it will provide a long term solution year-on-year with the guarantee of 100% recyclability at the end of a building's life.



# overview

## products and services

PVCu

### WINDOWS

slimSASH	flushSASH	sculpturedSASH	chamferedSASH	Tilt & Turn	Vertical SASH
	Revival	Mock Sash			Charisma
French Window	French Window	French Window	French Window		Heritage
					Ultimate

### DOORS

Residential	flushSASH	Bi-Folding Door	Sliding Patio
Panel			
French Door	French Door		

aluminium

### WINDOWS

MODERN	HERITAGE	TRADITIONAL	SHEERLINE®
AW685	AW686	AW610	CLASSIC
AW624	AW614	AW613	PRESTIGE
		AW690	
French Window	French Window	French Window	

### DOORS

RESIDENTIAL	SLIDING PATIO	BI-FOLDING
Panel	BSC94	ALUMINA
		BSF70
		F82
French Door		

composite

### SOLID COMPOSITE

Residential	Stable
French Door	

### GRP COMPOSITE

Residential
-------------

services

### SERVICES

CLOUD	APPLICATION	FINISHING	REWARDS
Window Designer	NRG Connect	colourTEK	
Solution Centre	roofTEK		
Customer Website			

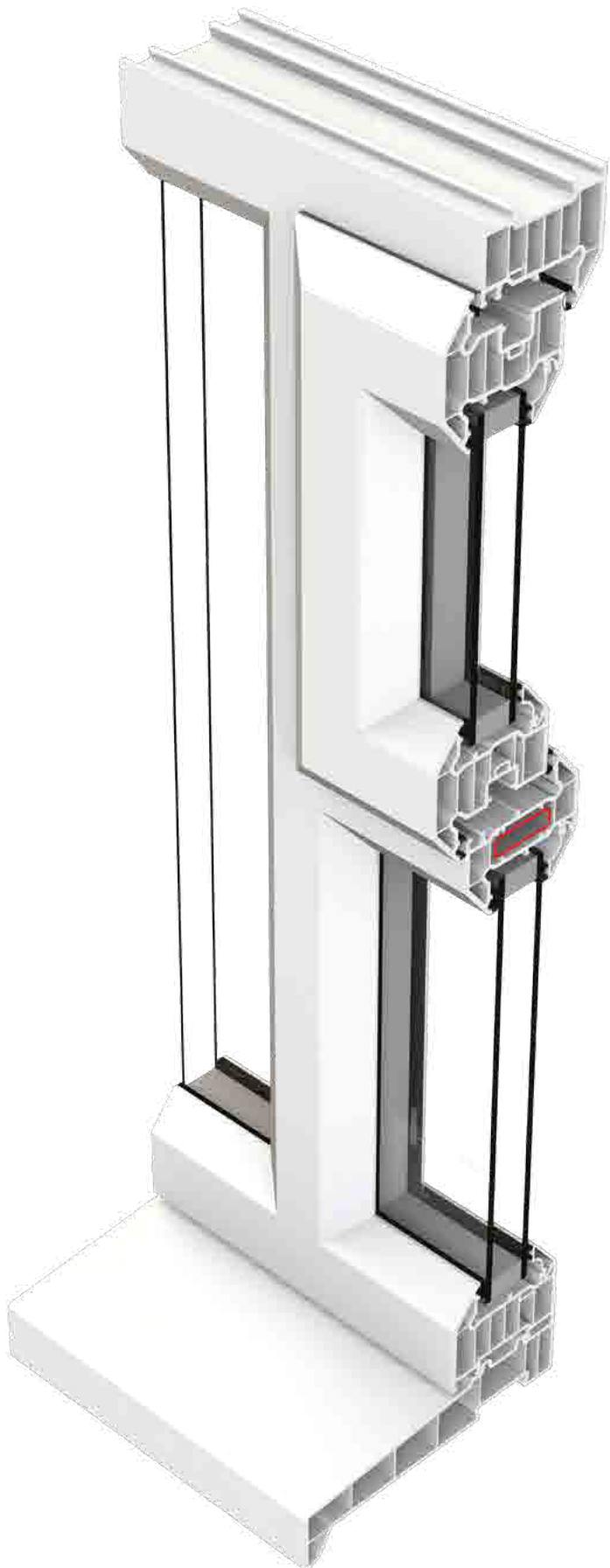

**PlatinumNRG slimSASH** casement windows are OUR most popular choice available today. The sashes or opening vents of these 70mm PVCu windows use a special slim profile, exclusive to **PlatinumNRG**.

**slimSASH** has a larger glass area which allows more daylight into your home, but still achieves outstanding energy efficiency due to its 6-chamber sash design. **slimSASH** is available in an extensive range of finishes.

Externally, the sashes are identified by a slim chamfered profile with a subtle feature groove surrounding the glass unit. These slim profile PVCu windows have a chamfered external profile with a choice of chamfered or sculptured internal beading.

**PlatinumNRG** use a patented co-extruded bubble gasket provides an effective seal against the weather adding to the energy efficiency of the window. This co-extruded bubble gasket is fabricated with the profile and has been tested to BFRC energy rating standards with zero air leakage.





# slimSASH

slim sight-line casement windows

SIGHTLINES	99mm
SASH WIDTH	70mm

## options

### HARDWARE FINISHES

- WHITE
- BRIGHT CHROME
- GRAPHITE
- ANTHRACITE
- BLACK
- ANTIQUE BLACK
- BRIGHT BRONZE
- GOLD

### FINISHES



Wide range of smooth and woodgrain foils

**OPTIONAL**  
Mechanically-jointed  
outer frame

### BEAD OPTIONS

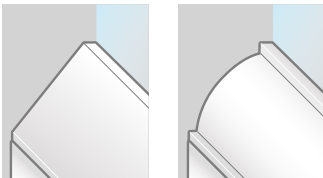

CHAMFERED      SCULPTURED

VIEWED FROM  
INSIDE



70mm PROFILE  
PVCu

ENERGY RATED UP TO **A+**

PAS24 STANDARD

PVC-u



Introducing a low maintenance PVCu window with a flush-fit, timber appearance.

The **PlatinumNRG flushSASH** design is reminiscent of a traditional, pre-1932 timber window and has become increasingly popular in conservation areas as a result.

Depending on the colour or foil finish you choose, the **flushSASH** range can offer a modern, contemporary appearance too – so it complements almost every property style.

As with the rest of the **PlatinumNRG** range, the **flushSASH** system has been designed from scratch by a team of experts, with A+ energy ratings and U-values as low as 0.9 W/m<sup>2</sup>K.







# flushSASH

timber alternative casement window

SIGHTLINES **104mm**

## options

### HARDWARE FINISHES

WHITE

BRIGHT CHROME

GRAPHITE

ANTHRACITE

BLACK

ANTIQUÉ BLACK

BRIGHT BRONZE

GOLD

### FINISHES



Wide range of smooth and woodgrain foils

**OPTIONAL**  
Mechanically-jointed  
outer frame and sash

### BEAD OPTIONS

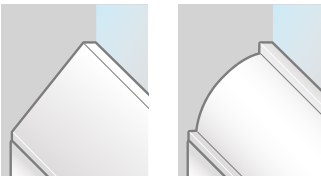

CHAMFERED

SCULPTURED

**Platinum<sup>®</sup>**  
**NRG**

70mm FRAME

PVC-u



VIEWED  
FROM INSIDE

ENERGY RATED UP TO **A+**

**PAS24 STANDARD** ON WELDED FRAMES

PVC-u



## TRADITIONAL TIMBER-LOOK PVCU

**PlatinumNRG Revival flushSASH** faithfully replicates period timber window styling, right down to the details of conventional timber hardware, such as traditional handles and working peg stays. Revival takes a magical step back in time for the great looks of authentic timber window detailing but with all the benefits of low maintenance PVCu.

### TRADITIONAL FINISHES\*\*

WHITE

SATIN CHROME

POLISHED CHROME

GRAPHITE

BLACK

PEWTER PATINA

BRONZE RED TINT

ANTIQUÉ BRONZE

ELECTRO GOLD

### CONTEMPORARY FINISHES\*\*

BRIGHT CHROME

GRAPHITE

GOLD

ANTIQUÉ BLACK

\*\* Due to different suppliers, hardware names for the contemporary finishes **DO NOT** correspond with the names of the traditional finishes

The unique new 85mm deep frame incorporates seven chambers, for optimal thermal performance and strength. A classic, deep sculptured edge detail with transoms and mullions that can be mechanically jointed to replicate traditional mortise and tenon joints.

Based on the thermally efficient PlatinumNRG FlushSASH system, Revival offers the realism of a pre-1930's timber window combined with 21st century benefits - featuring a number of exclusive enhancements.





# REVIVAL<sup>®</sup> flushSASH

deep reveal outer frame

SIGHTLINES 104mm

## options

### HARDWARE FINISHES

WHITE

BRIGHT CHROME

GRAPHITE

ANTHRACITE

BLACK

ANTIQUÉ BLACK

BRIGHT BRONZE

GOLD

### OPTIONAL

Mechanically-jointed  
outer frame and sash

### WINDOW FINISHES



Wide range of smooth and  
woodgrain foils

**Platinum<sup>®</sup>**  
**NRG**

70mm FRAME

PVC-u

VIEWED  
FROM INSIDE



ENERGY RATED UP TO **A+**

**PAS24 STANDARD** ON WELDED FRAMES

PVC-u



## TRADITIONAL TIMBER-LOOK PVCU

**PlatinumNRG Revival SASH** highlights the fact that the 85mm outer frame will accept any of our slim, chamfered or sculptured sashes including aluminium.

The deep reveals internally and the deeper cills externally offer an authentic timber frame or sub-frame appearance.

### TRADITIONAL FINISHES\*\*

WHITE

SATIN CHROME

POLISHED CHROME

GRAPHITE

BLACK

PEWTER PATINA

BRONZE RED TINT

ANTIQUÉ BRONZE

ELECTRO GOLD

### CONTEMPORARY FINISHES\*\*

BRIGHT CHROME

GRAPHITE

ANTIQUÉ BLACK

GOLD

\*\* Due to different suppliers, hardware names for the contemporary finishes **DO NOT** correspond with the names of the traditional finishes



### BEAD OPTIONS

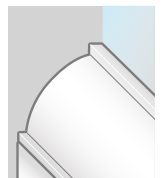

CHAMFERED

SCULPTURED



# REVIVAL<sup>®</sup> SASH

deep reveal outer frame

SIGHTLINES 104mm

## options

### HARDWARE FINISHES

WHITE

BRIGHT CHROME

GRAPHITE

ANTHRACITE

BLACK

ANTIQUÉ BLACK

BRIGHT BRONZE

GOLD

### WINDOW FINISHES



Wide range of smooth and woodgrain foils

### OPTIONAL

Mechanically-jointed outer frame and sash

**Platinum<sup>®</sup>**  
**NRG**

85mm PROFILE

PVCu



VIEWED FROM INSIDE

ENERGY RATED UP TO **A+**

**PAS24 STANDARD** ON WELDED FRAMES

PVC-u

# chamferedSASH

chamfered frame, choice of beads

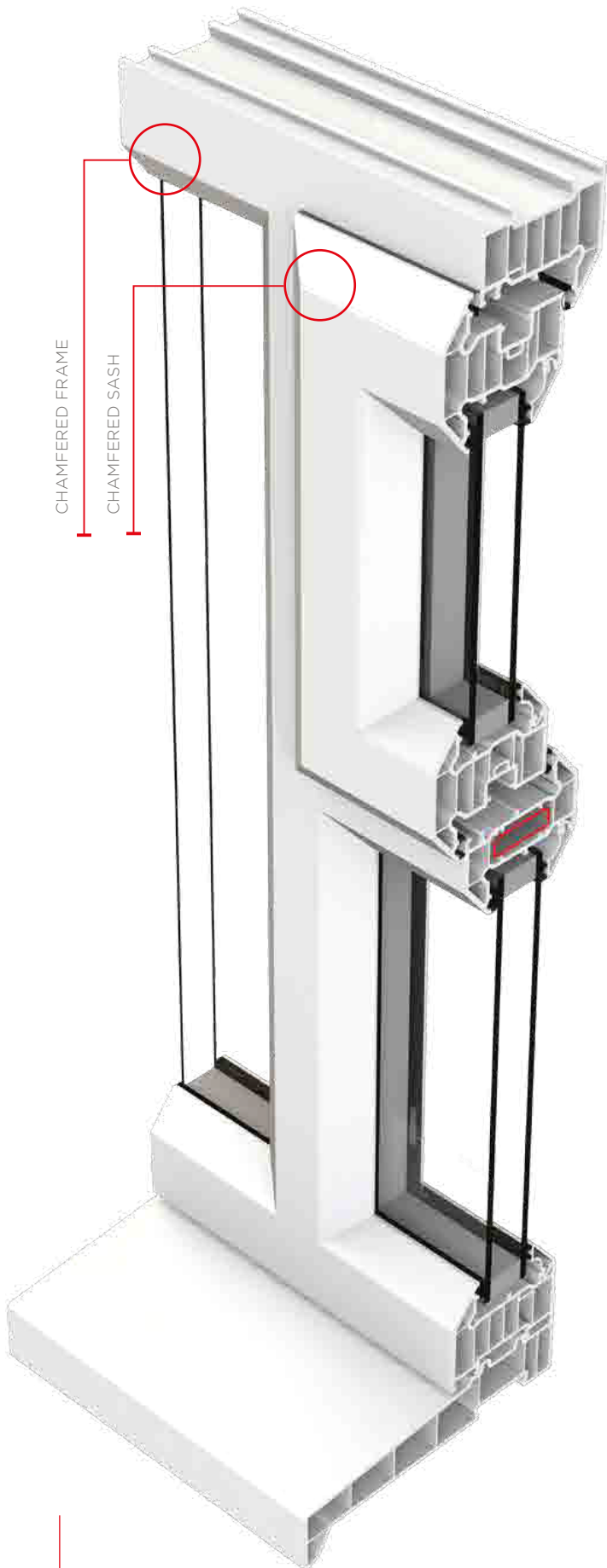

**PlatinumNRG chamferedSASH** and **sculpturedSASH** are at the core of our casement window range. They can be had with either a sculptured frame, sash and beads or with a chamfered frame, sash and beads - as their name suggests.

Both systems are similar to **slimSASH** in terms of design and performance - the key difference is that the sashes are 5mm wider.

A 6-chamber sash and frame profile ensures excellent thermal performance and the structural design of the profile ensures a strong and rigid installation.

In it's sculptured form, it suites perfectly with the Alumina bi-fold door system too.

## BEAD OPTIONS



CHAMFERED

SCULPTURED

SIGHTLINES **104mm**





# sculpturedSASH

sculptured frame, choice of beads

SIGHTLINES 104mm

## options

### HARDWARE FINISHES

WHITE

BRIGHT CHROME

GRAPHITE

ANTHRACITE

BLACK

ANTIQUÉ BLACK

BRIGHT BRONZE

GOLD

### WINDOW FINISHES



Wide range of smooth and woodgrain foils

### OPTIONAL

Mechanically-jointed outer frame and sash

### BEAD OPTIONS



CHAMFERED



SCULPTURED



70mm FRAME

PVC-u



VIEWED FROM OUTSIDE

ENERGY RATED UP TO **A+**

**PAS24 STANDARD**

PVC-u



The open-in style of window is very much a European design and is ideal for cleaning from within (in the turn position).

Ideal for high-rise as well as low-rise applications, the tilt and turn window offers a greater scope for larger opening lights than a traditional casement window and the larger panes of glass help with thermal performance. Larger glazing also allows for more light coming in and a greater view out.

Perfect as a fire escape or simply to let in more fresh air, most windows are supplied as 'tilt before turn' to make them safer and avoid the risk of children opening them fully in the first instance.

With many practical benefits, **PlatinumNRG flushSASH Tilt and Turn** windows are also available with as many options as our popular casement windows.







# tilt & turn window

inward opening multi-opening casement

SIGHTLINES

111mm

## options

### HARDWARE FINISHES

WHITE

BRIGHT CHROME

GRAPHITE

ANTHRACITE

BLACK

ANTIQUE BLACK

BRIGHT BRONZE

GOLD

### WINDOW FINISHES



Wide range of smooth and woodgrain foils

### BEAD OPTIONS



CHAMFERED



SCULPTURED

**Platinum<sup>®</sup>**  
**NRG**

70mm FRAME

PVC-u



VIEWED  
FROM INSIDE

ENERGY RATED UP TO **B**

**PAS24 STANDARD** WITH CONCEALED GEARING

PVC-u

# French window

inward/ outward opening double casement



**SIGHTLINES 103mm**

Using sculpturedSASH or chamferedSASH

**SIGHTLINES 99mm**

Using slimSASH



VIEWED FROM OUTSIDE

**OPTIONAL**  
Mechanically-jointed outer frame and sash

**BEAD OPTIONS**

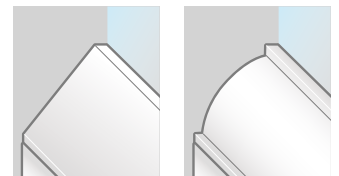

CHAMFERED

SCULPTURED

French Windows are an extension of both the **PlatinumNRG chamferedSASH** and **sculpturedSASH** casement window range. With a floating mullion they are perfect fire escape windows and offer compliant egress in most situations.

With a continually warming climate they provide the maximum opening size for ventilation and offer a truly unobstructed view.



# flush French window

flush-sash inward/ outward opening double casement

SIGHTLINES 103mm

## options

### HARDWARE FINISHES

WHITE

BRIGHT CHROME

GRAPHITE

ANTHRACITE

BLACK

ANTIQUÉ BLACK

BRIGHT BRONZE

GOLD

### WINDOW FINISHES



Wide range of smooth and woodgrain foils

VIEWED FROM OUTSIDE

**OPTIONAL**  
Mechanically-jointed outer frame and sash

### BEAD OPTIONS

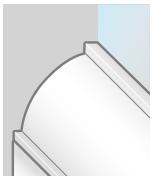

SCULPTURED

**Platinum<sup>®</sup>  
NRG**

70mm FRAME

PVC-u



flush French Windows are an extension of the **PlatinumNRG flushSASH** casement window. With a floating mullion they are perfect fire escape windows and offer compliant egress in most situations.

**B**

ENERGY RATED UP TO

**PAS24 STANDARD WITH CONCEALED GEARING**

PVC-u

The **PlatinumNRG V-SASH Ultimate** is the epitome of the NRG Collection design philosophy – an outstandingly authentic, exceptionally-performing work of art.

The V-SASH Ultimate was one of the very first PVCu sash windows to be cleared for use in conservation areas – and it's still the best. With slim timber-like profiles and a 35mm meeting rail, no other sash window looks as authentic. And with period features as painstakingly detailed as full mechanical joints, deep bottom rail and external putty lines, it would take an expert to tell it apart from a genuine timber sash.

What's more, you get all that careful craftsmanship, historic detailing and vintage appeal with the all-round exceptional performance of twenty-first century PVCu. It's why we call it the V-SASH Ultimate.

#### V-SASH Ultimate Period Features

It's the little things that make the NRG Rose special – the tiny details that make it virtually indistinguishable from a classic timber sash.

#### The Outside



**Meeting rail with RTH**



**Full mechanical joints**



**Traditional globe claw furniture**



**Woodgrain finish**



# v-sash ultimate

fully-featured, vertical-sliding sash window



Mechanically  
jointed  
throughout

External  
putty  
lines

Authentic  
astragal  
bars

Slim  
35mm  
meeting  
rail

Run-through  
sash horn

Woodgrain  
finish

Deep  
bottom  
rail

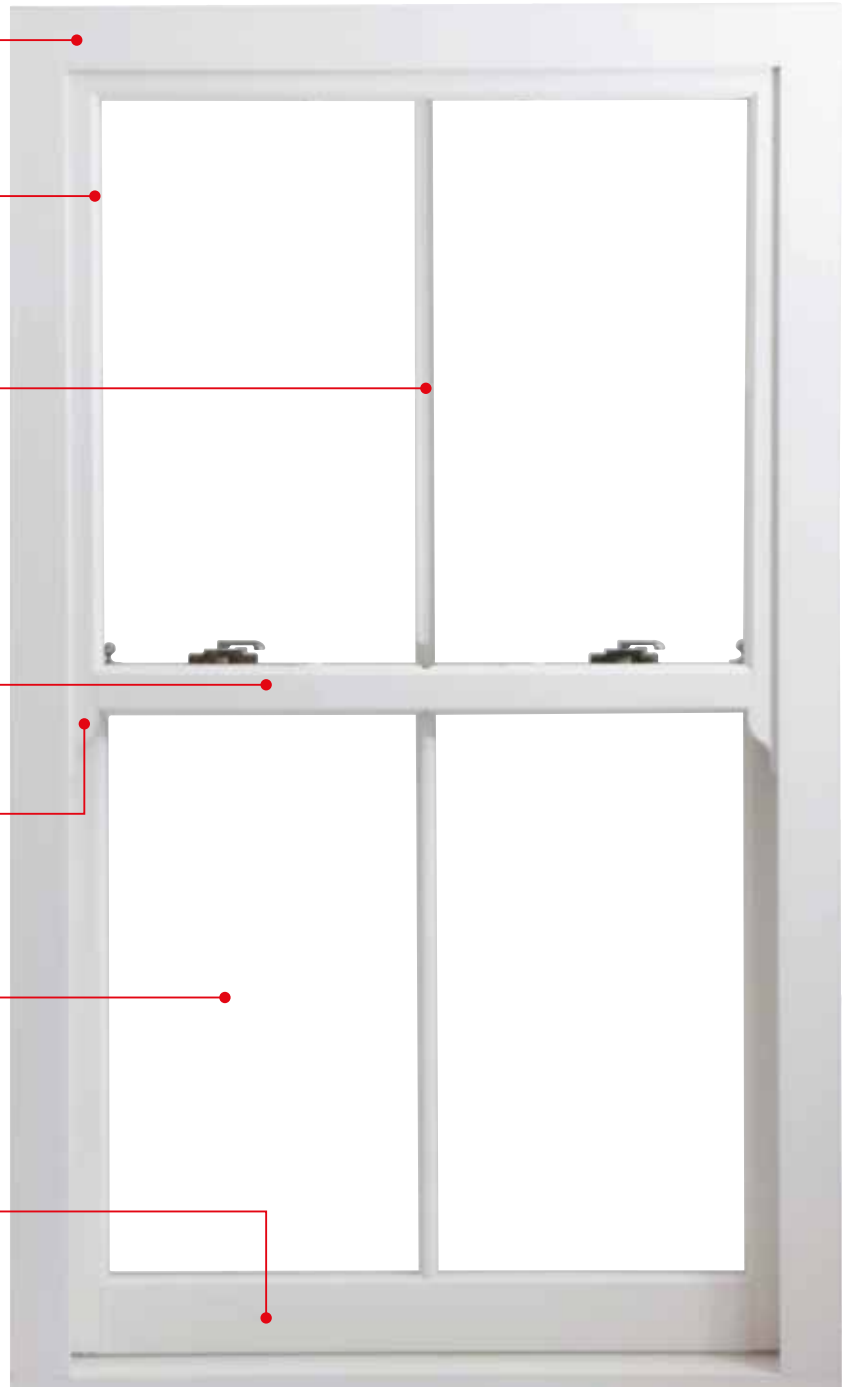

MEETING RAIL 35mm



PVC-u

THE COMPLETE FENESTRATION COMPANY

PVC-u

Authenticity is the watchword of the **PlatinumNRG V-SASH Heritage**. Accepted for use in conservation areas as discerning as the London Borough of Kensington and Chelsea, Lincoln, Worcester, and Cambridge, the Heritage Rose looks every inch the iconic timber sash window – while delivering the convenience and all-round excellence of modern PVCu.

All around the UK, more and more people are choosing the **V-SASH Heritage** when it comes to replacing their existing windows – won over by a generous selection of colour and finishing options, its robust energy and security performance, and, above all, its incomparable vintage charm.

With its sleek sight-lines, deep bottom rail, external putty lines and other period detailing, the **V-SASH Heritage** is near-indistinguishable from a timber original, offering a level of class and authenticity second only to the **V-SASH Ultimate**.

#### The Outside



Meeting rail with RTH



Acorn hardware



Optional polished weld



Deep bottom rail



# v-sash heritage

authentic, vertical-sliding sash window



Authentic  
putty  
lines

Authentic  
astragal  
bars

44mm  
meeting  
rail

Optional  
run-through  
horn

Deep  
bottom  
rail



MEETING RAIL **44mm**

Platinum<sup>®</sup>  
NRG

PVC-u

THE COMPLETE FENESTRATION COMPANY

PVC-u

Take one of the most respected PVCu systems on the market and turn it into an impeccably stylish timber-effect sash window – that’s the genius of the **PlatinumNRG V-SASH Modern**.

With a more contemporary appearance than either of its NRG Collection siblings, the V-SASH Modern is a hugely versatile window, ideally suited to everything from upgrading existing windows on older properties to adding retro-chic to newly built homes.

Inward tilting for easy cleaning, hassle-free maintenance and an extensive variety of finishing and hardware options make the V-SASH Modern one of the all-round best sash windows currently available.

The V-SASH Modern delivers affordable authenticity – a significant cut above your standard PVCu sash with both its vintage detailing, and outstanding all-round performance. Made-to-measure V-SASH Modern won’t rattle, warp or rot – and will deliver standout features

#### The Outside



Anti-jemmy rail



Optional run-through sash horn



Acorn hardware



Welded joints





# v-sash modern

contemporary, vertical-sliding sash window



Sculptured feature profile

Authentic astragal bars

Modern 60mm meeting rail

Clip-on sash horn

Anti-jemmy protection

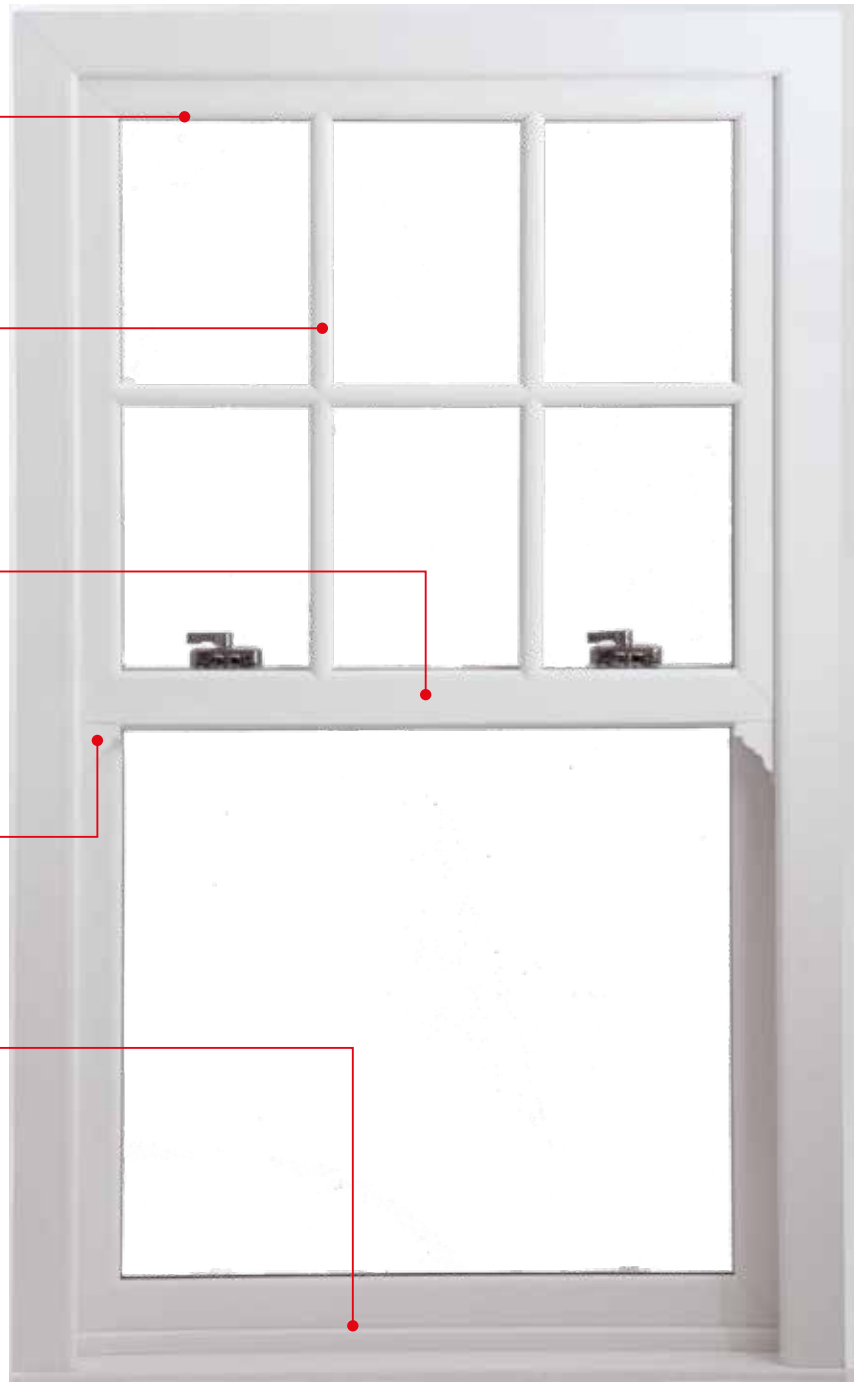

MEETING RAIL 60mm

Platinum<sup>®</sup>  
NRG

PVC-u

THE COMPLETE FENESTRATION COMPANY

PVC-u



**PlatinumNRG Residential Doors** are available in a range of colours to match your windows and a multitude of glass and panel designs, you can rest assured that you will find the perfect match for any property.

Security is of paramount importance and this is why we offer some of the most secure locking systems. That's why we partner with companies such as Ingenious® for our door security.

**PlatinumNRG Residential Doors** are available in a variety of obscure glass options, enhancing the privacy of a property.

Held into place under compression and gasketed using the **PlatinumNRG** patented double action bubble seal, double rebated doors provide superior levels of weather tightness and zero air leakage.





# residential door

high performance entrance door

SIGHTLINE 136mm

## options

### HARDWARE FINISHES

WHITE

BRIGHT CHROME

GRAPHITE

ANTHRACITE

BLACK

ANTIQUE BLACK

BRIGHT BRONZE

GOLD

### WINDOW FINISHES



Wide range of smooth and woodgrain foils

### BEAD OPTIONS

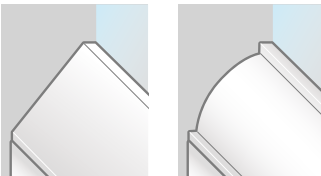

CHAMFERED

SCULPTURED

**Platinum<sup>®</sup>**  
**NRG**

70mm FRAME

PVC-u



VIEWED  
FROM  
OUTSIDE

PAS24 UPGRADEABLE

PVC-u



As with our lipped casement/ storm-proof residential door, the **PlatinumNRG flush Residential Door** offers the same benefits and features but with a flush-fitting door leaf within the outer frame.

It's the natural choice for front and rear entrances where either **flushSASH** or **flushSASH Revival** windows are being used. The flatter appearance suits modern and traditional properties alike - frames and sashes can be co-ordinated or matched, depending on the style of property.



LIPPED/ STORM-PROOF



FLUSH



# flush residential door

flush-sash entrance door

SIGHTLINE 136mm

## options

### HARDWARE FINISHES

WHITE

BRIGHT CHROME

GRAPHITE

ANTHRACITE

BLACK

ANTIQUE BLACK

BRIGHT BRONZE

GOLD

### WINDOW FINISHES



Wide range of smooth and woodgrain foils

### BEAD OPTIONS



CHAMFERED

SCULPTURED

**Platinum<sup>®</sup>**  
**NRG**

70mm FRAME

PVC-u

VIEWED  
FROM  
OUTSIDE



PAS24 UPGRADEABLE

PVC-u



**THRESHOLD OPTIONS**

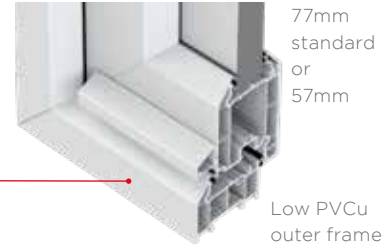

FRAME ONLY

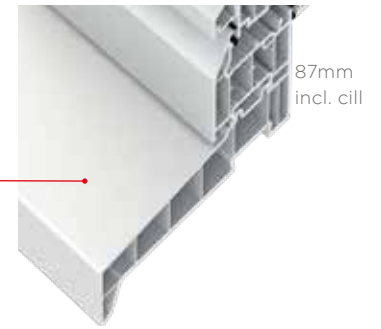

FRAME AND CILL

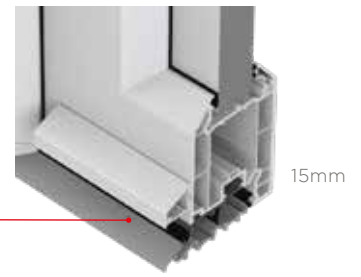

ALUMINIUM PART M COMPLIANT

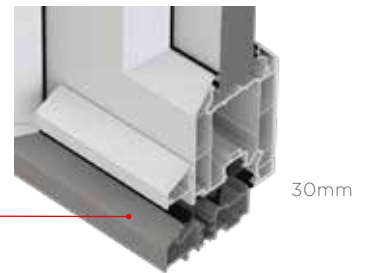

ALUMINIUM LOW THRESHOLD

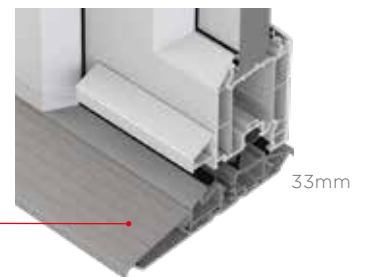

ALUMINIUM LOW THRESHOLD AND TRAY RAMP

**ALL VIEWED FROM OUTSIDE, INWARD-OPENING DOOR LEAF  
ALL AVAILABLE OUTWARD OPENING**



# door styles

multiple configurations

SIGHTLINE 136mm

## options

### HARDWARE FINISHES

WHITE

BRIGHT CHROME

GRAPHITE

ANTHRACITE

BLACK

ANTIQUÉ BLACK

BRIGHT BRONZE

GOLD

### DOOR FINISHES



Wide range of smooth and woodgrain foils

### BEAD OPTIONS

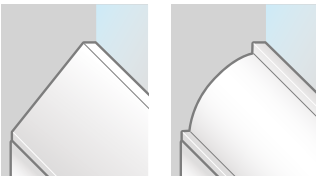

CHAMFERED

SCULPTURED



70mm FRAME

PVC-u



VIEWED FROM OUTSIDE, INWARD-OPENING DOOR LEAF

PAS24 UPGRADEABLE

PVC-u

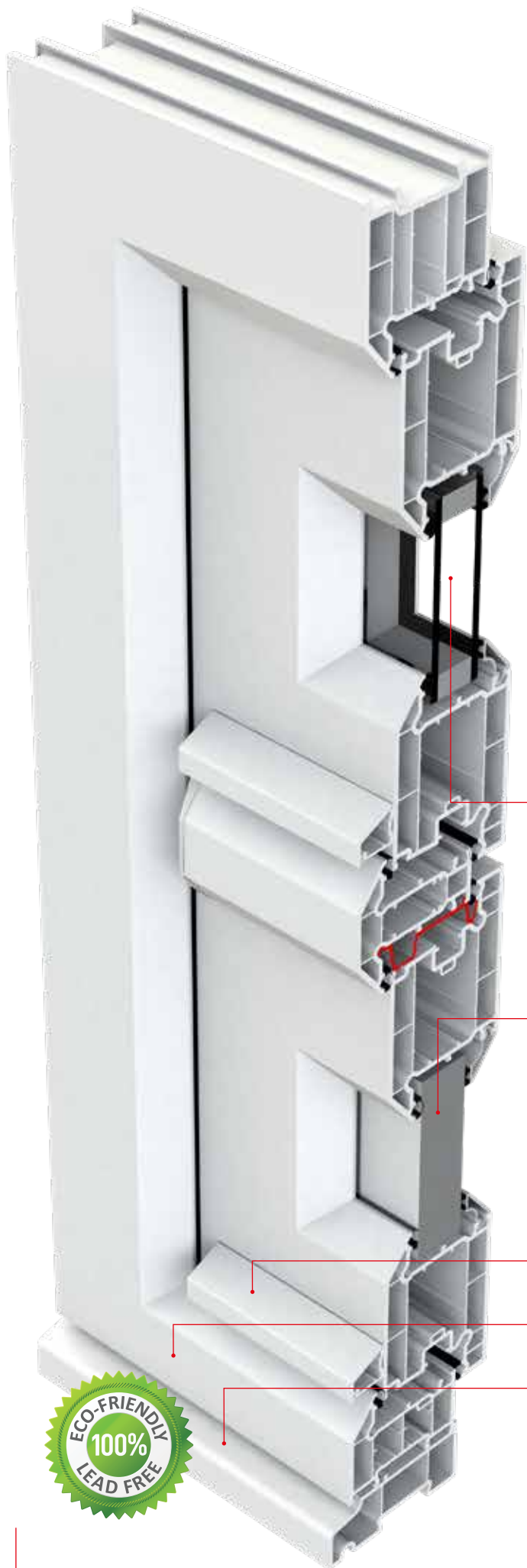

**THIS EXAMPLE SHOWS THE CHAMFERED FRAME IN AN INWARD-OPENING CONFIGURATION**

**100% LEAD FREE PVCu**  
Completely free of poisonous lead stabilisers.

**GLOSS FINISH**  
Polished finish reduces cleaning and maintenance and retains a cleaner look for longer helping resist airborne pollutants and moulds.

Double-glazed unit available for entire door or by using additional transoms and mullions just for parts of the door.

Solid REINFORCED panels available for entire door or by using additional transoms and mullions just for parts of the door.

Weather bar

LOW PVCu threshold

Stub cill

**THRESHOLD OPTIONS**

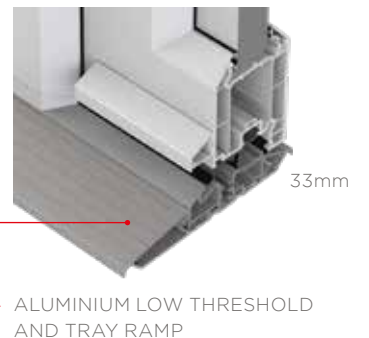
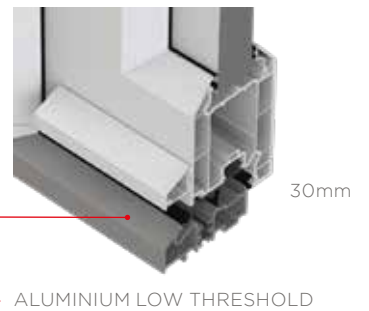
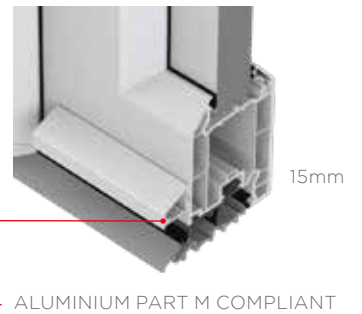
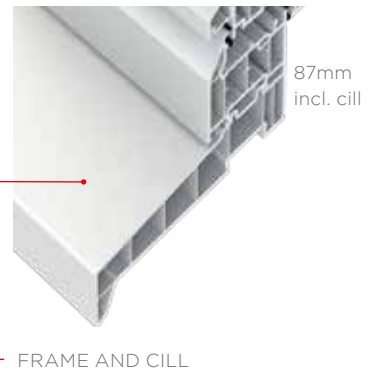
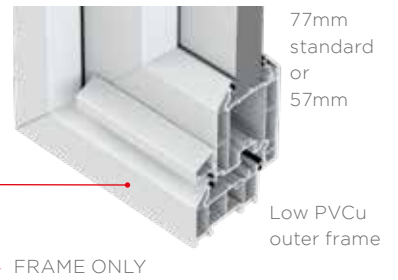





# stable door

versatile, stylish and secure

## options

### HARDWARE FINISHES

WHITE

BRIGHT CHROME

GRAPHITE

ANTHRACITE

BLACK

ANTIQUÉ BLACK

BRIGHT BRONZE

GOLD

### WINDOW FINISHES



Wide range of smooth and woodgrain foils

### BEAD OPTIONS

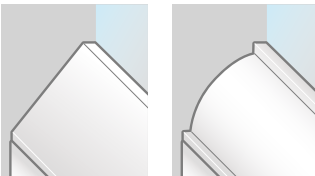

CHAMFERED

SCULPTURED



VIEWED FROM INSIDE

**Platinum<sup>®</sup>**  
**NRG**

70mm FRAME

PVC-u

PVC-u

# French door

high performance double door



**PlatinumNRG PVCu French Doors** transform the look of any home and have been manufactured to meet the highest security standards.

A choice of hinges including a projecting flag hinge or a slim SFS Dynamic hinge are available and denote whether a door can be folded back flat against the adjacent window leaf.

The doors suite perfectly with the **PlatinumNRG PVCu** casement windows and offer the same option of a chamfered or sculptured glazing bead.

**PlatinumNRG PVCu French Doors** are tested against the extreme weather conditions including wind and water tightness, hard and soft body and cycle test.

#### BEAD OPTIONS



CHAMFERED

SCULPTURED

SIGHTLINE **136mm**

MEETING STILE **225mm**



SHOWN WITH FLAG HINGES, OUTWARD OPENING



# flush French door

high performance double door

SIGHTLINE **132mm**

MEETING STILE **195mm**

## options

### HARDWARE FINISHES

WHITE

BRIGHT CHROME

GRAPHITE

ANTHRACITE

BLACK

ANTIQUÉ BLACK

BRIGHT BRONZE

GOLD

### WINDOW FINISHES



Wide range of smooth and woodgrain foils

### BEAD OPTIONS

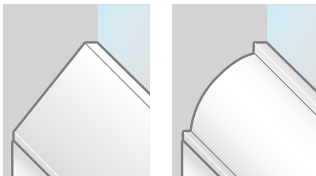

CHAMFERED

SCULPTURED



SHOWN WITH BUTT HINGES, OUTWARD OPENING

**Platinum<sup>®</sup>**  
**NRG**

70mm FRAME

PVC-u

PVC-u



**PlatinumNRG PVCu Bi-Fold Doors** will transform, modernise and add real value to your home.

Your home will be lighter and brighter. Enjoy the feeling of more space. Our bi-folding doors are some of the most attractive, simple to use, energy efficient and secure on the market. Designed to enhance your home they will maximise the space available.

Fully opened the **PlatinumNRG PVCu Bi-Fold Doors** are slim and unobtrusive, and when closed they offer all the benefits of a modern double glazed patio door.

Slim frames give you more glass, less PVCu and more natural light. The hardware is concealed so only the hinge knuckles show.

Low threshold options are ideal for wheelchair users and family homes as they create fewer trip hazards for the elderly and the very young.

Available in a varied range of colours and finishes, your door can easily be tailored to suit your personal taste and home.

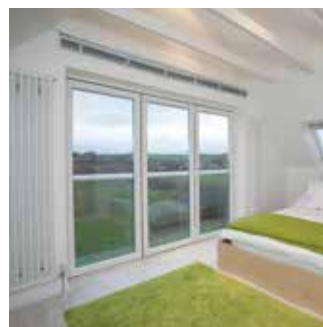



# bi-fold door

sculptured-leaf, bi-folding door system

MEETING STILE **174mm**

SIGHTLINE **132mm**

## options

### HARDWARE FINISHES

WHITE

BRIGHT CHROME

GRAPHITE

ANTHRACITE

BLACK

ANTIQUÉ BLACK

BRIGHT BRONZE

GOLD

### WINDOW FINISHES



Wide range of smooth and woodgrain foils

### BEAD OPTIONS



CHAMFERED

SCULPTURED

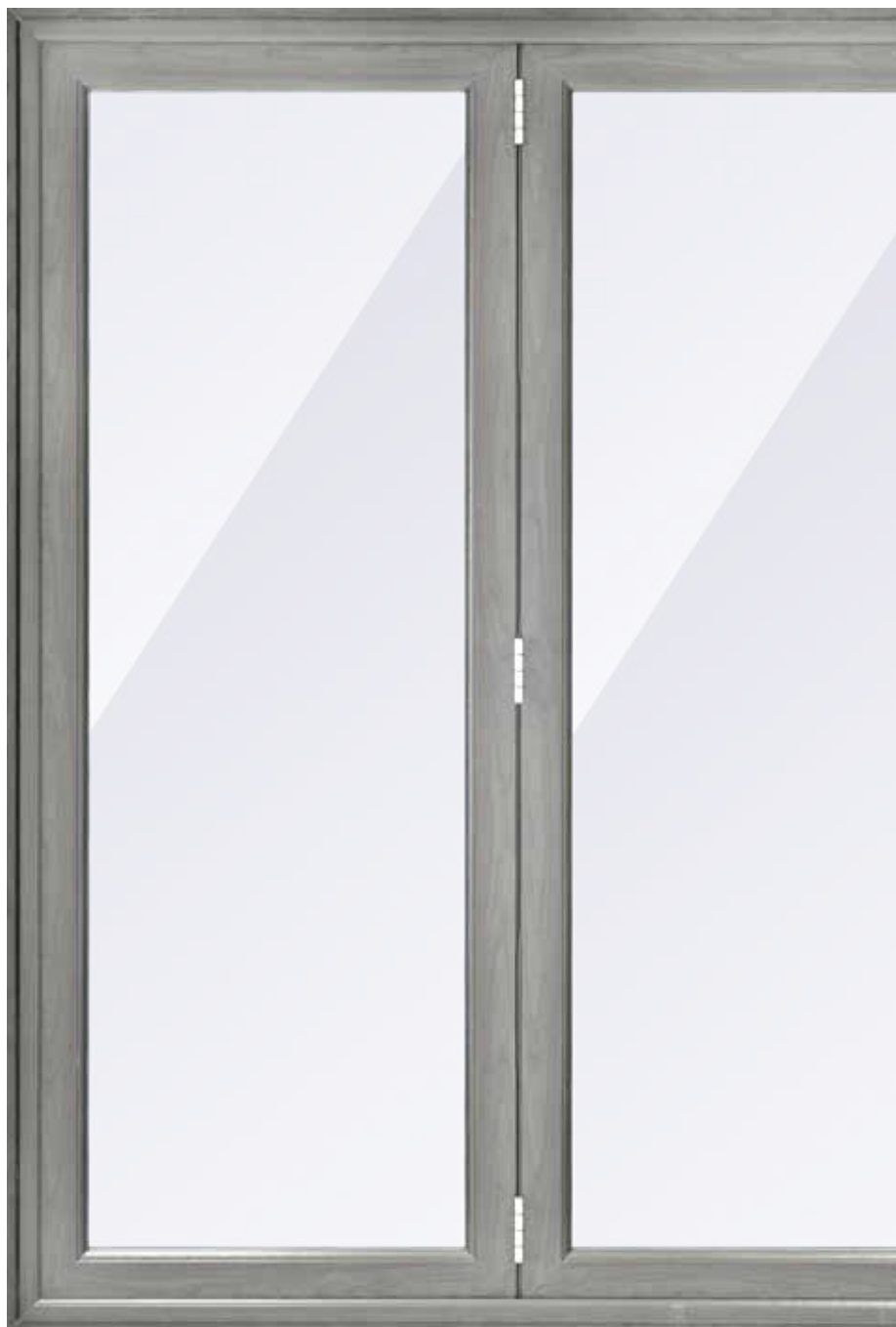

VIEWED FROM INSIDE

**Platinum<sup>®</sup>**  
**NRG**

70mm FRAME

PVC-u

PAS24 UPGRADEABLE

PVC-u



Other patio door systems operate on a four-wheel mechanism made of steel. The roller on **PlatinumNRG PVCu Sliding Patio Doors** features an eight-wheel acetal system, designed to provide a unique 'air glide' smooth, silent rolling motion.

The roller is forgiving for installers, as it's designed to self-adjust and work with the product – even over misaligned surfaces. It also has a staggering load capacity for glazed panes up to 120kg per sash.

Thermally broken, the low-threshold offers increased energy efficiency for your patio doors, and there's also a Part-M compliant low threshold with an integral ramp for seamless access.





# sculptured patio door

sculptured-profile sliding patio door

INTERLOCK **84mm**

SIGHTLINE **122mm**

## options

### HARDWARE FINISHES

WHITE

BRIGHT CHROME

GRAPHITE

ANTHRACITE

BLACK

ANTIQUE BLACK

BRIGHT BRONZE

GOLD

### WINDOW FINISHES



Wide range of smooth and woodgrain foils



### BEAD OPTIONS

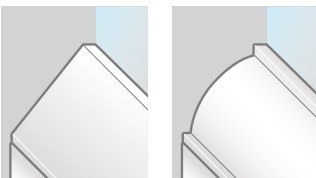

CHAMFERED

SCULPTURED

**Platinum<sup>®</sup>**  
**NRG**

70mm FRAME

PVC-u

PVC-u

## Secured by Design



OFFICIAL POLICE SECURITY INITIATIVE

**PlatinumNRG Sliding Patio+ Doors** operate in the same manner as our standard patio door but use a chamfered profile rather than sculptured profile.

Hardware choices differ from the standard patio door too.

PAS24 and Secured by Design are standard features of the Patio+ Doors.







# chamfered patio door

chamfered-profile sliding patio door

INTERLOCK **88mm**

SIGHTLINE **122mm**

### BEAD OPTIONS

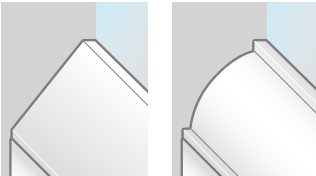

CHAMFERED    SCULPTURED

## options

### HARDWARE FINISHES

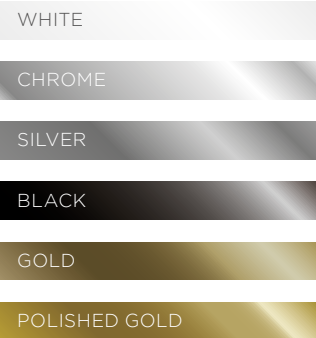

### WINDOW FINISHES



Wide range of smooth and woodgrain foils



PAS24 STANDARD



PVC-u



70mm FRAME

PVC-u

THE COMPLETE FENESTRATION COMPANY

AW690

AW624

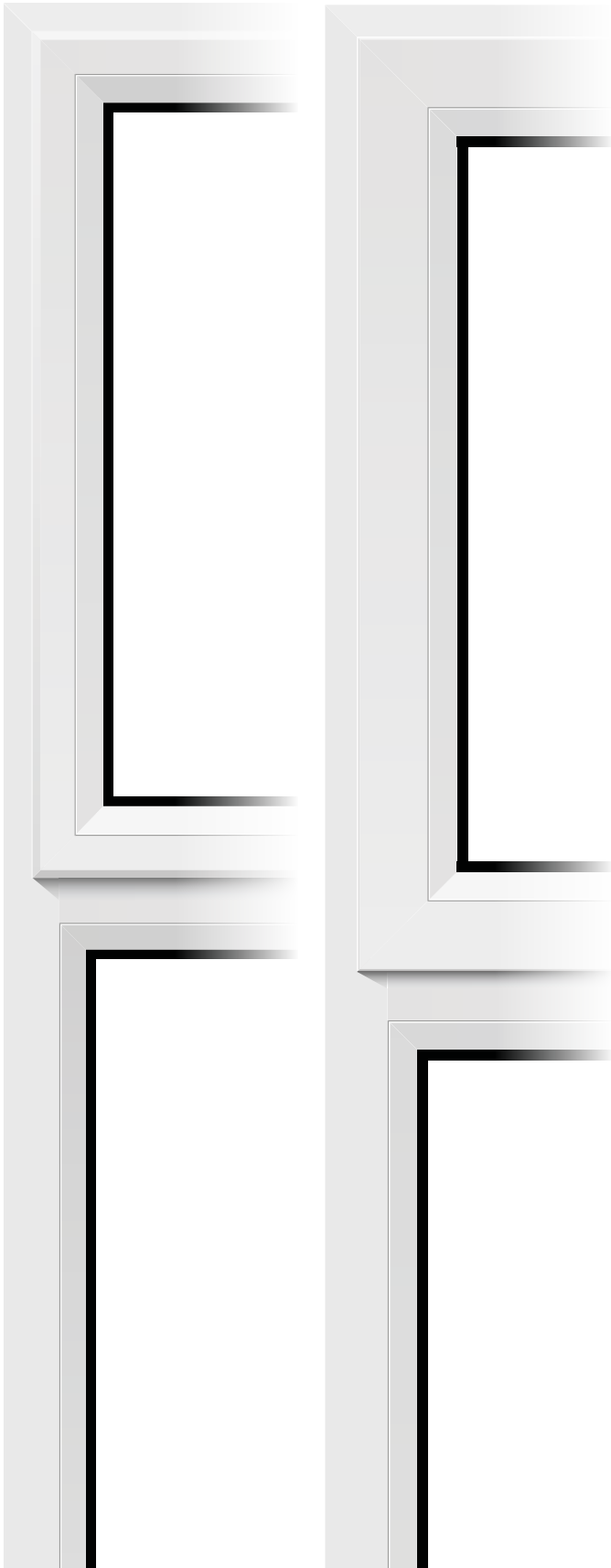

The **PlatinumNRG Modern Aluminium Range** encompasses slim, flat sashes together with large expanses of glass to offer an almost uninterrupted view from within.

Opening up a room to let the light flood in, these windows have narrow framing and can offer uninterrupted glazing to a height of 2 storeys. Get the look with the ultimate in maximum glazing, minimum framing aluminium window systems and add a whole new perspective to your home.

A flatter, slimmer sash help define the style of the **PlatinumNRG Modern Aluminium Range** with a square or chamfered glazing bead. Simple, sleek lines work on many styles of property but probably more suited to a modern home.

Through innovative design and superior build quality this window system offers high thermal and acoustic performance alongside the inherent strength and low maintenance benefits of aluminium to make your home safe and secure.





# modern aluminium

AW685, AW624 and AW690

SIGHTLINE AW685 **64mm**

SIGHTLINE AW624 **76mm**

SIGHTLINE AW690 **64mm**

## options

### HARDWARE FINISHES

WHITE

BRIGHT CHROME

GRAPHITE

ANTHRACITE

BLACK

ANTIQUE BLACK

BRIGHT BRONZE

GOLD

### WINDOW FINISHES



Wide range of BS and RAL colours available

### BEAD OPTIONS

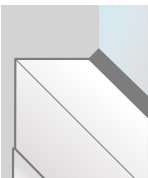

SQUARED



CHAMFERED



VIEWED FROM OUTSIDE

AW685

**A**  
**B**  
ENERGY RATED UP TO

**PAS24** UPGRADEABLE

Aluminium



Aluminium

THE COMPLETE FENESTRATION COMPANY

## AW610

## AW613

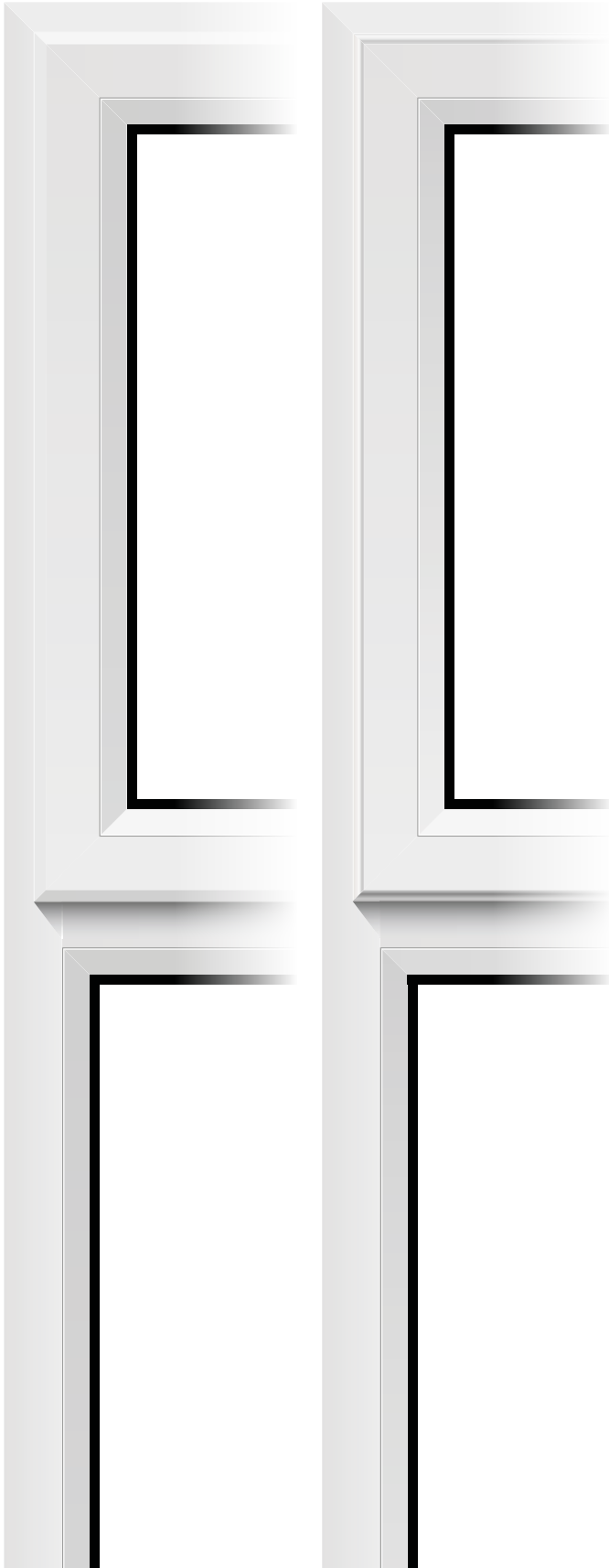

Highly flexible and adaptable, our **PlatinumNRG Traditional Range** is ideal for homeowners looking for a traditional framing look.

### AW610

The sash protrudes from the frame with a **chamfered** profile around the outer edges along with a **chamfered** glazing bead.

The chamfered glazing bead emulates the style of a typical timber window as it gives the appearance of having held the glass in place with putty - what we refer to as a 'putty-line'.

### AW613

Our traditional **Ovolo** window is essentially the same window as our traditional Chamfered but uses a sculptured (or **Ovolo**) profile around the outer edges of the sash. This gives the sash a more decorative appearance and is often referred to as 'soft-line'.

Again, this would be found on period timber windows and can be glazed with either the putty-line chamfered bead or a square bead.





# traditional aluminium

AW613 and AW610

SIGHTLINE AW613 **76mm**

SIGHTLINE AW610 **76mm**

## options

### HARDWARE FINISHES

WHITE

BRIGHT CHROME

GRAPHITE

ANTHRACITE

BLACK

ANTIQUÉ BLACK

BRIGHT BRONZE

GOLD

### WINDOW FINISHES



Wide range of BS and RAL colours available

### BEAD OPTIONS



SQUARED

CHAMFERED



ENERGY RATED UP TO **B**

**PAS24** UPGRADEABLE

Aluminium



Aluminium

THE COMPLETE FENESTRATION COMPANY

AW614

AW686

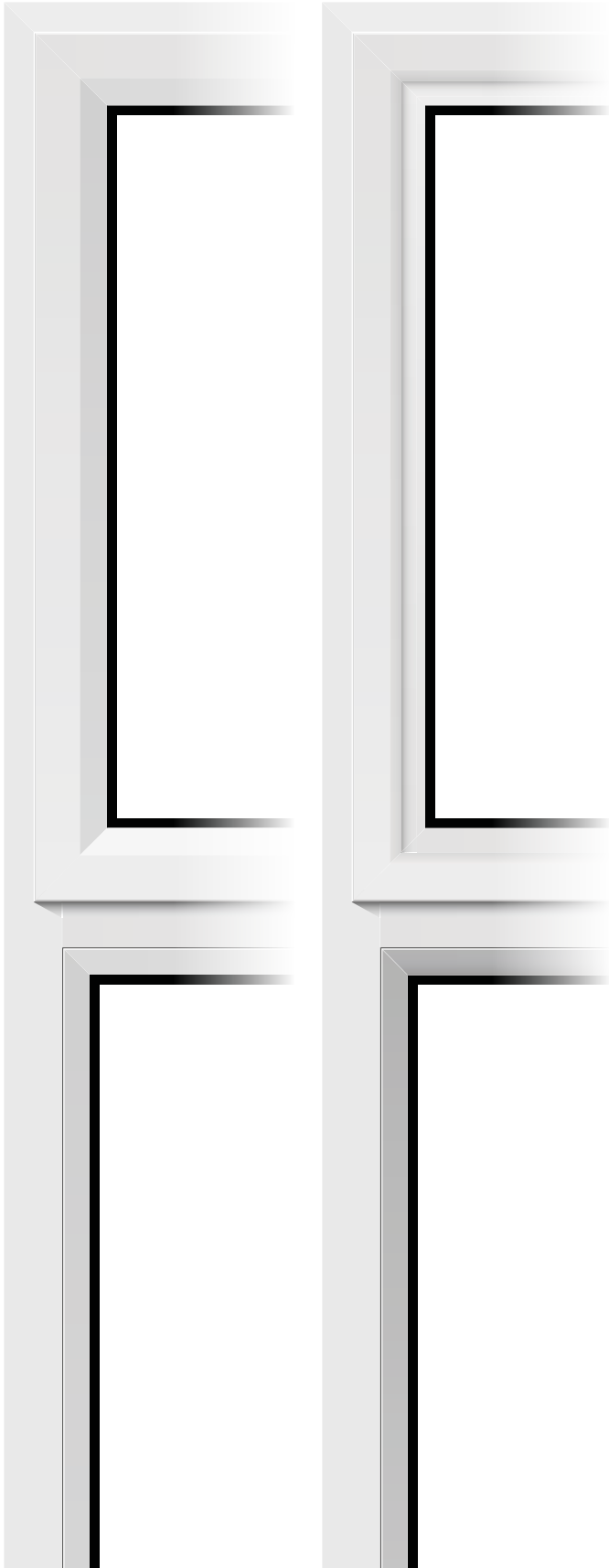

Our **PlatinumNRG Heritage** windows are an ideal replacement for current steel-framed glazing in your home.

Manufactured from lightweight aluminium, they offer a higher performance alternative to traditional alternatives, whilst still retaining the look and style of your property.

Designed to improve thermal and acoustic performance, this system is low maintenance and customisable, yet still replicates the narrow sight lines that traditional steel windows provide.

A choice of either a 'stepped' Crittall-style AW686 or a chamfered 'putty line' AW614 profile capture the style and elegance of the British heritage steel windows that were predominantly used throughout the last century.





# heritage aluminium

AW614 and AW686

SIGHTLINE AW614 **64mm**

SIGHTLINE AW686 **64mm**

## options

### HARDWARE FINISHES

WHITE

BRIGHT CHROME

GRAPHITE

ANTHRACITE

BLACK

ANTIQUÉ BLACK

BRIGHT BRONZE

GOLD

### WINDOW FINISHES



Wide range of BS and RAL colours available

### BEAD OPTIONS



FLAT



**A** ENERGY RATED UP TO

**PAS24** UPGRADEABLE

Aluminium

AW614

Aluminium

THE COMPLETE FENESTRATION COMPANY



The ultra slim 59mm sightlines maximise incoming light, while our patented construction method – using threaded screws to bind corners tightly together in perfect unison – creates perfect run through mitres on internal joints, doing away with the unsightly junctions of square cut beads seen on ordinary aluminium windows.

We've also designed out the stepping of misaligned corners, allowing each Sheerline window to be individually hand tuned to perfection. Leaving you with the perfect balance of understated refinement and exacting quality standards.





# classic aluminium

revolutionary Sheerline® system



Aluminium

SIGHTLINE 59mm

Platinum<sup>®</sup>  
NRG

U
VALUE
DOUBLE
1.4
w/m <sup>2</sup> K

64/72mm FRAME

Aluminium

Built around an innovative **Thermavic®** multi-chamber thermal break, our windows use a patented construction method that offers unsurpassed levels of security. Creating windows that are strong and durable, yet with slim frames that maximise the light flooding into your home. Sheerline aluminium windows are also available in a wide range of colours, letting you express your home's character.

Single and  
French doors.

Available as single  
and French door  
(French also available  
as flush with  
sidelights and flags,  
with full mid-rail  
options.)





# prestige aluminium

revolutionary Sheerline® system



Aluminium

**Platinum**  
**NRG**

72/80mm FRAME  
Aluminium

**U**  
VALUE  
TRIPLE  
**0.9**  
w/m<sup>2</sup>K

**U**  
VALUE  
DOUBLE  
**1.4**  
w/m<sup>2</sup>K

Casement, French and Tilt and Turn windows  
Can accommodate the largest spans and biggest windows. 72mm front to back as standard, - in-line with the Classic flush profile width - allowing the systems to be joined. 80mm for Flush frames.

modern, versatile, premium.



<b>U</b> VALUE DOUBLE <b>1.9</b> w/m <sup>2</sup> K	<b>U</b> VALUE TRIPLE <b>1.7</b> w/m <sup>2</sup> K
---	---

## DUAL TRACK

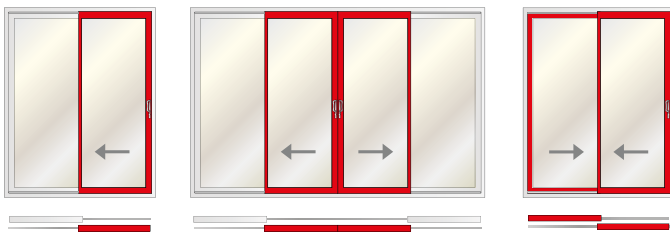

## TRIPLE TRACK

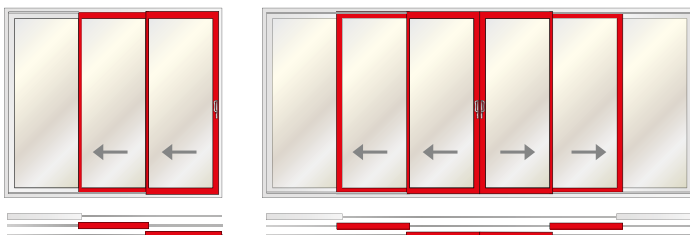

Combining high performance with stunning design, our sliding aluminium door systems provide a versatile solution for any architectural project. Manufactured to the highest UK standards, this multi-configuration in-line system offers outstanding thermal performance and a wide range of customisable options.



# sliding patio door

## BSC94 & BSC94 SLIM

INTERLOCK 85mm

INTERLOCK SLIM 45mm

SIGHTLINE 115mm

### options

#### HARDWARE FINISHES

WHITE

BRIGHT CHROME

GRAPHITE

ANTHRACITE

BLACK

ANTIQUÉ BLACK

BRIGHT BRONZE

GOLD

#### WINDOW FINISHES



Wide range of BS and RAL colours available



Elegant, lockable patio door handles available in a range of finishes

PAS24 UPGRADEABLE

Aluminium

### STANDARD

- 85mm interlock
- 28mm double-glazed
- Spanning up to 6 leaves wide
- Range of widths and height combinations
- High performance for air-tightness, water tightness and wind loading

### OPTIONS

- Document Q compliance
- Triple-glazed
- Range of hardware and security features
- 45mm interlock - BSC94 SLIM
- Multiple sliding configurations
- Dual or triple track options
- Single or dual colour



Aluminium

THE COMPLETE FENESTRATION COMPANY

53



Uniquely designed, the Alumina bi-fold is a 'true' aluminium door, being able to span widths up to 1.2 metres per sash and up to 2.5 metres in height. Optional warm-touch foiled exterior with superior U-values - yet all manufactured in the same way as other aluminium systems.

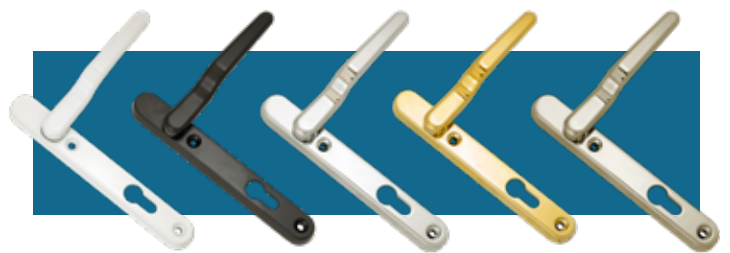



# bi-fold door

**ALUMINA** sculptured-profile with optional foiled finish

MEETING STILES	156mm
SIGHTLINES	125mm

## options

### HARDWARE FINISHES

- WHITE
- BRIGHT CHROME
- GRAPHITE
- ANTHRACITE
- BLACK
- ANTIQUE BLACK
- BRIGHT BRONZE
- GOLD

### WINDOW FINISHES



Wide range of BS and RAL colours available



Wide range of smooth and woodgrain foils

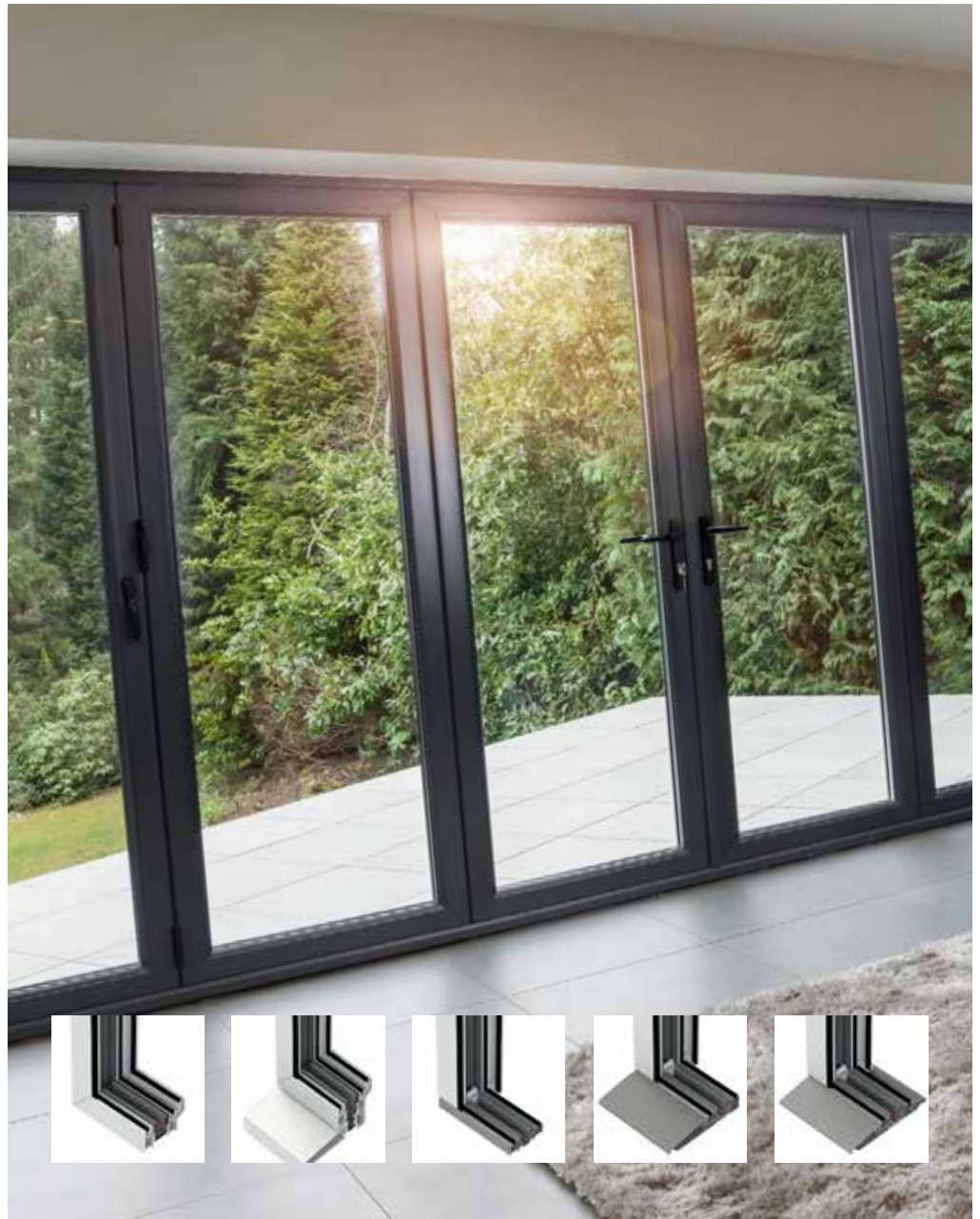

PAS24 UPGRADEABLE

Aluminium



Alumina takes all the benefits of an aluminium door and adds extra features to make it the perfect choice where you need strength with size. And as it's designed to perfectly match Liniar's range of thermally efficient PVCu windows, you can mix and match for an overall cost effective installation.



An intelligent combination of form and function, our highly versatile **PlatinumNRG BSF70** and market-leading bi-fold sliding door system gives you maximum control over the style and operation of the doors. Multiple panels can be added to accommodate the design specifications of your building, with the option to open in or out as required.

The system also boasts a unique flush line pop-out handle that allows for square flush stacking panels when doors are fully open.



<b>U</b> VALUE TRIPLE	<b>U</b> VALUE DOUBLE
<b>1.4</b>	<b>1.8</b>
w/m <sup>2</sup> K	w/m <sup>2</sup> K

## STANDARD

- 28mm double-glazed
- Spanning up to 7 panes wide
- Leaf sizes up to 1200mm and up to 2400mm high
- Unique pop-out handle for flat stacking
- Chamfered or Square glazing bead
- Four stainless steel rollers for smooth operation
- High performance for air-tightness, water tightness and wind loading

## OPTIONS

- Document Q compliance
- Triple-glazed
- All configurations are open-in/ open-out
- Chamfered and square bead options
- Available in a range of opening configurations
- Available in a range of single or dual colours
- Low threshold 34mm or 22mm step height
- Chamfered and Square based options
- Interlock shoot-bolts for enhanced security
- Dedicated bottom bogey guide
- Double track threshold for stability





# bi-fold door

## Optio BSF70 radiused-profile

MEETING STILES **140mm**

SIGHTLINES **110mm**

### options

#### HARDWARE FINISHES

WHITE

BRIGHT CHROME

GRAPHITE

ANTHRACITE

BLACK

ANTIQUÉ BLACK

BRIGHT BRONZE

GOLD

#### WINDOW FINISHES



Wide range of BS and RAL colours available



**Platinum<sup>®</sup>**  
**NRG**

Aluminium



PAS24 UPGRADEABLE

Aluminium



<b>U</b>
VALUE
TRIPLE
<b>0.9</b>
w/m <sup>2</sup> K

<b>U</b>
VALUE
DOUBLE
<b>1.3</b>
w/m <sup>2</sup> K

A contemporary, stylish bi-folding door. With slimmer sight-lines and an interlock of 122mm that provides larger glazing panels without compromising on performance.



## STANDARD

- 28mm double glazed
- Unique flush pop-out handle for ease of operation, removing the need for additional unsightly handles
- Unique traffic door handle
- Heavy duty compact rollers as standard
- Both frame and cill sight-lines of 97mm
- 122mm slim-line interlock
- Larger glazing area

## OPTIONS

- Square bead
- Triple glazed
- Available in a range of opening configurations
- Available in a range of single or dual colour and anodised finishes
- All configurations available open in and open out



# bi-fold door

## Luminia F82 slim, chamfered-profile

MEETING STILES **122mm**

SIGHTLINE **97mm**



UPGRADEABLE TO **PAS24**



It also offers HD compact slim stainless steel rollers as standard allowing for a smoother movement when opening and closing. And with the flush pop-out handle, form and function work in perfect harmony.



Aluminium

Aluminium

THE COMPLETE FENESTRATION COMPANY



## Stunning Aesthetics

The woodgrain finish on a **PlatinumNRG GRP** composite door is developed from oak tree wood grain, creating a beautifully authentic appearance and superior performance that is only available on a **PlatinumNRG GRP** door.

Our range of colours, styles and glass options will make your door truly unique and by ensuring that we perfectly match the colour, wood grain and moulding on the glazing cassettes, you can guarantee a flawless finish.

Our glass designs complement our door styles and colours and are triple glazed and laminated as standard for extra security and energy efficiency.



# entrance door

GRP composite doors

## Enhanced Security

Our **PlatinumNRG GRP** composite door offers enhanced security thanks to its rigid polymer sub-frame, high density insulated core and high impact resistant GRP skin.

The door leaf and glazing system are major components when part of a door set and have a proven ability to achieve PAS24:2016, industry's enhanced security standard, a prerequisite in attaining certification to Secured by Design a police initiative to protect against unlawful intrusion.



**Platinum<sup>®</sup>**  
**NRG**

PAS24 UPGRADEABLE

Composite

Composite

THE COMPLETE FENESTRATION COMPANY

61



**Fortrezz** doors are renowned for their strength and security, our 48mm thick cross-banded veneered laminated solid timber core delivers unrivalled strength and dimensional stability and is a natural choice for high security, providing our homeowners peace of mind.



# entrance door

## FORTREZZ® solid timber-core composite

A CHOICE OF  
20 DOOR COLOURS



WHITE



CREAM



PEBBLE



DUCK EGG  
BLUE



CHARTWELL  
GREEN



TURQUOISE



PEARL  
GREY



ELEPHANT  
GREY



ANTHRACITE  
GREY



SCHWARZ  
BRAUN



FRENCH  
NAVY



RACING  
GREEN



RICH RED



IRISH OAK



GOLDEN  
OAK



WALNUT



MAHOGANY



ROSEWOOD

Many composite doors on the market utilise a traditional 'stile and rail' internal subframe, which offers inferior performance when compared to our solid LVL core.

Stile and rail sub-frames are usually filled with either a PU foam core, or a mix-species timber core. This notably reduces the inherent strength of the door, and can even result in some doors bowing due to the lack of structural integrity.



PAS24 UPGRADEABLE

Composite

Choose from the Classic, Metro or Country collection to bring a personal touch to your home. Our composite doors are able to offer everything from country charm to the cutting-edge flair of the modern day.



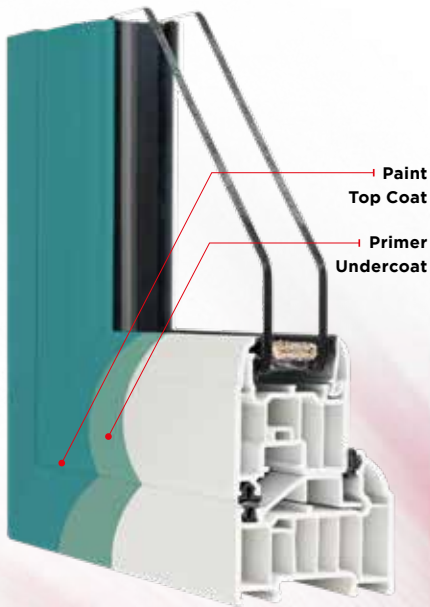

Previous generation spray paint finish often necessitating an undercoat/primer. The paint adheres to the undercoat which in turn adheres to the substrate. The paint sits on top of the substrate and consequently is prone to abrasion and chipping.

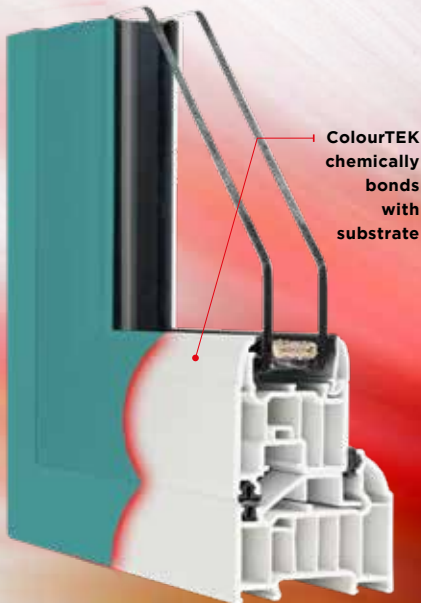

Molecular Cross Bonding (MCB) uses a chemical process to bond and combine with the substrate it's being applied to. The substrate can be PVCu or aluminium and either of these can have a foiled woodgrain or powder-coated finish.



The bonding process ensures that even when different frames, door skins and materials are used, a consistent colour and finish can be applied for a uniquely co-ordinated appearance, including the gasket!





# colourTEK

molecular-bonded colour finish



Services

## In addition to our standard finishes...

Currently we can offer a huge choice of colours from the RAL and BS colour libraries to cover almost any traditional or modern architectural requirements.

We can offer this service on products that include windows, doors, composite doors and bi-folds.

**ColourTEK** is based at our own manufacturing facility which means excellent logistics for us as a company and as a consequence, improves turnaround times to our customers with better quality control.

Platinum<sup>®</sup>  
NRG



**Whiteline 360** focuses on each of 6 key stages of the business cycle, with a full and increasing menu of options for selection and detailing within each.

**Unique Products**, such as SlimSASH, FlushSASH and the new Revival System, create demand and distinction with PVCu, aluminium production and quality all in-house

**Exclusive Branding** using the PlatinumNRG brand and marketing support packages that help to promote and develop sales.

**Lead Generation** develops new business leads and sales demand for the installer to convert, providing an immediate sales pipeline for the retail installer.

**Business Support** tools ensure efficient and effective communications and administration, including selling aids and administrative efficiency tools.

**Service Delivery** cements best practice logistics from procurement to installation: and finally last but not least

**Relationship Management** is the people side of the day to day and strategic management of every interaction between Whiteline and the customer.

## VIRTUAL SHOWROOM

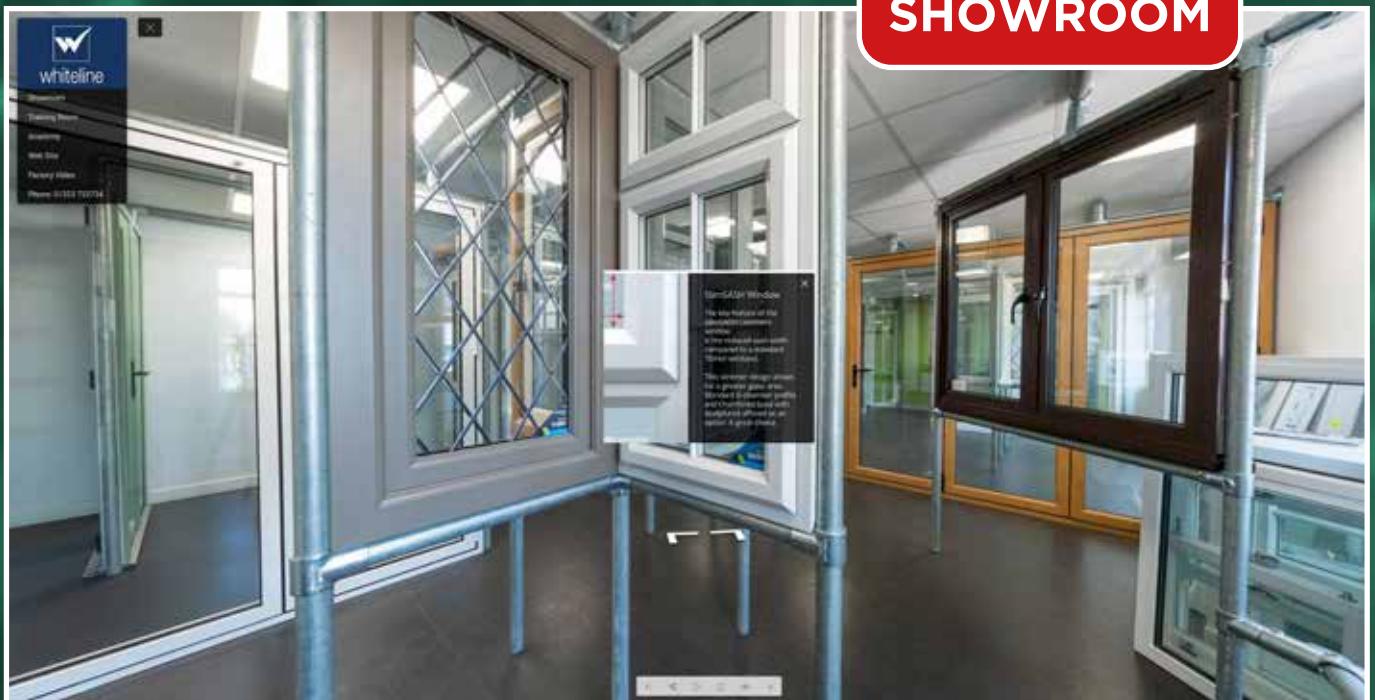

Our 'virtual showroom' gives an overview of our product range and enables a 'walk-through' that demonstrates window and door views from different angles.

# whiteline 360



Services



Platinum  
NRG

Services

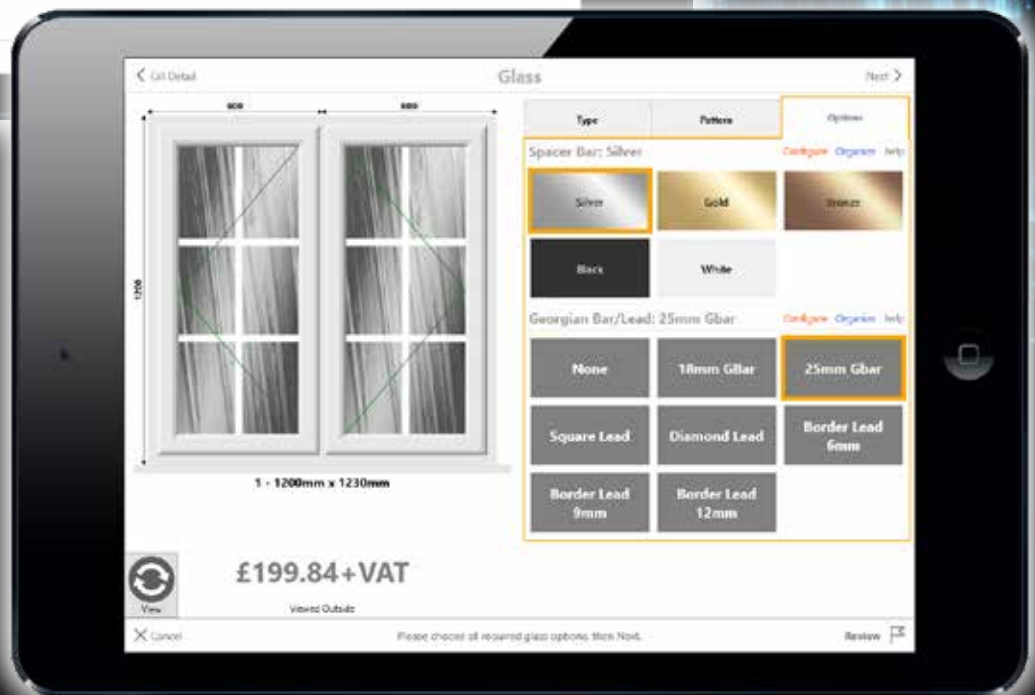

**NRG:Connect** works without the need for a mobile data connection, with all pricing calculations done on device. **NRG:Connect** offers a full high resolution photo realistic colour interface with reports generated, displayed and printed from the device again without the need for an Internet connection.

It's fast, simple and customer focused, with a visual front end that makes for the ultimate sales and survey experience. **NRG:Connect** offers customisable help & advice buttons at all levels allowing additional information to be added to help the user navigate with ease.

Automatic synchronisation via the cloud has been added to make it hassle free for end users to send & receive information to and from your **Window Designer** installation, eliminating the need for reprocessing information.

# NRG:Connect

quotation and survey application

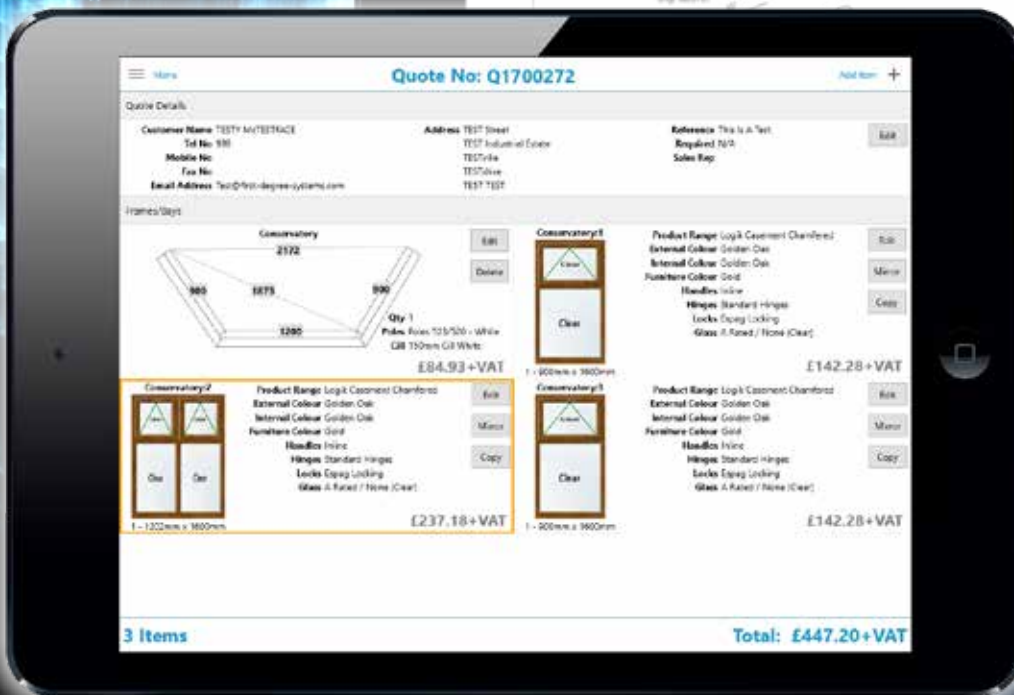

Services

Being able to capture all your requirements whilst with the customer is key. Stunning visuals and intuitive design allows you to work closely with clients to not only establish need but show the result.

Windows and doors can show both internal and external views and the cutting edge design engine allows users to see the actual handles and other hardware options in location on the product.



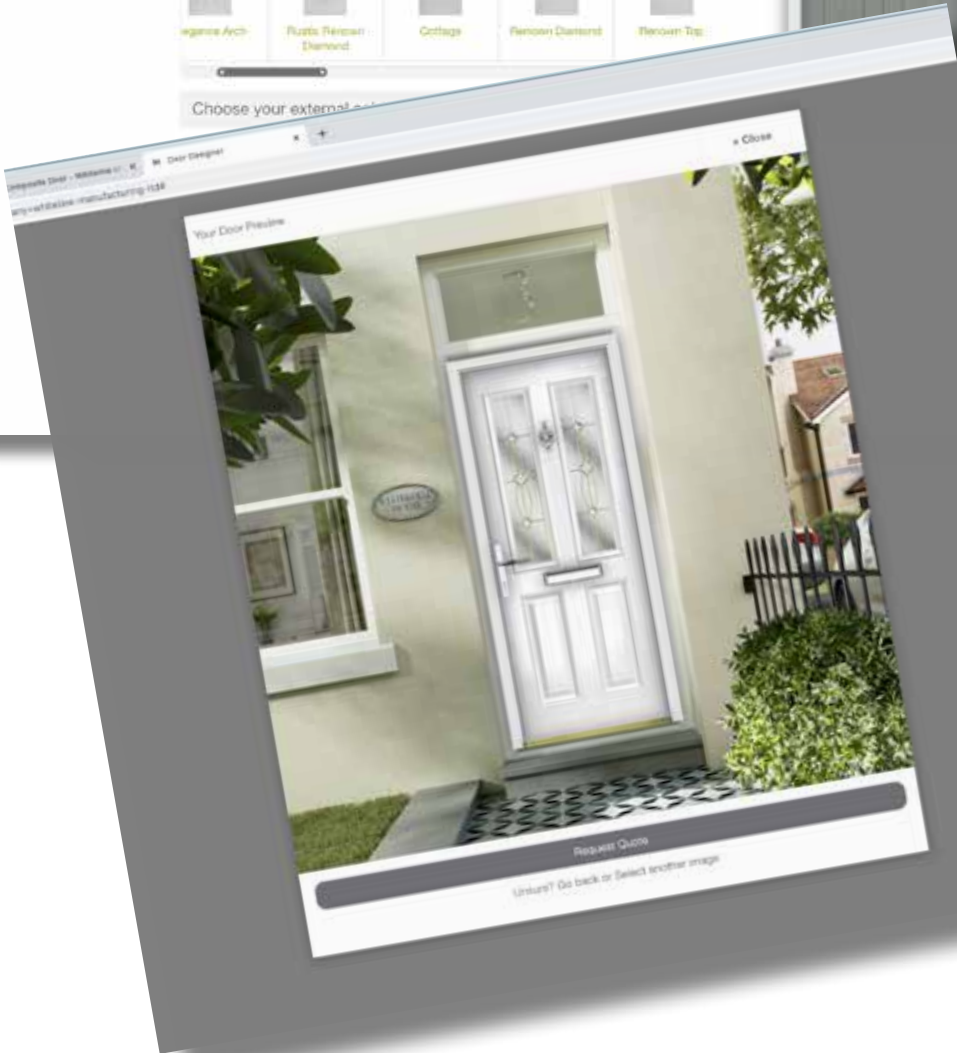

# door configurators

composite door design and visualisation

PlatinumNRG

Your premium brand for Windows, Doors & Conservatories

Call us today on 0800 8523151

About PlatinumNRG Products Online Designers Map Discover Videos Contact View Brochure Request a Quote

It's Our Full Screen Fortezza Door Configurator. Follow the steps on screen please check with your PlatinumNRG partner on availability

SEND ENQUIRY

Door Colour Golden Oak	Handle Heritage Lever/Lever
Frame Colour White/White	Hardware Colour Antique Black
Glazing Elizabeth Red	Frame Type Single Door / No Sidelights

Your chosen door is a **BERWYN**

Services

With a product range as diverse as PlatinumNRG it can be very difficult to convey the vast range of styles and finishes with brochures and websites.

This is where we can utilise digital technology to create 'virtual' products that demonstrate the style of window and door a customer maybe interested in. On top of this we can then colourise the product to match the finishes available for this product.





**We offer a full-training service in-house - not just for our staff but also for our expansive network of customers and their respective installation teams if ever required.**

We produce our own training videos to help convey practical information on everything from construction, repair and individual installation requirements.

Much of this training can be accessed through our customer portal - the Solution Centre.





# solution centre

web-based information centre



**Introducing our new web-based customer solution centre. The system offers facilities such as submitting tickets, viewing both current and historic tickets and their status.**

In addition, a comprehensive search capability enables you to find technical information, solution articles, images, videos and more and is fully mobile friendly when you are out and about.

We will be in contact with you shortly to help setup your access details and to answer any questions you may have.



<https://customersupport.whiteline.co.uk>

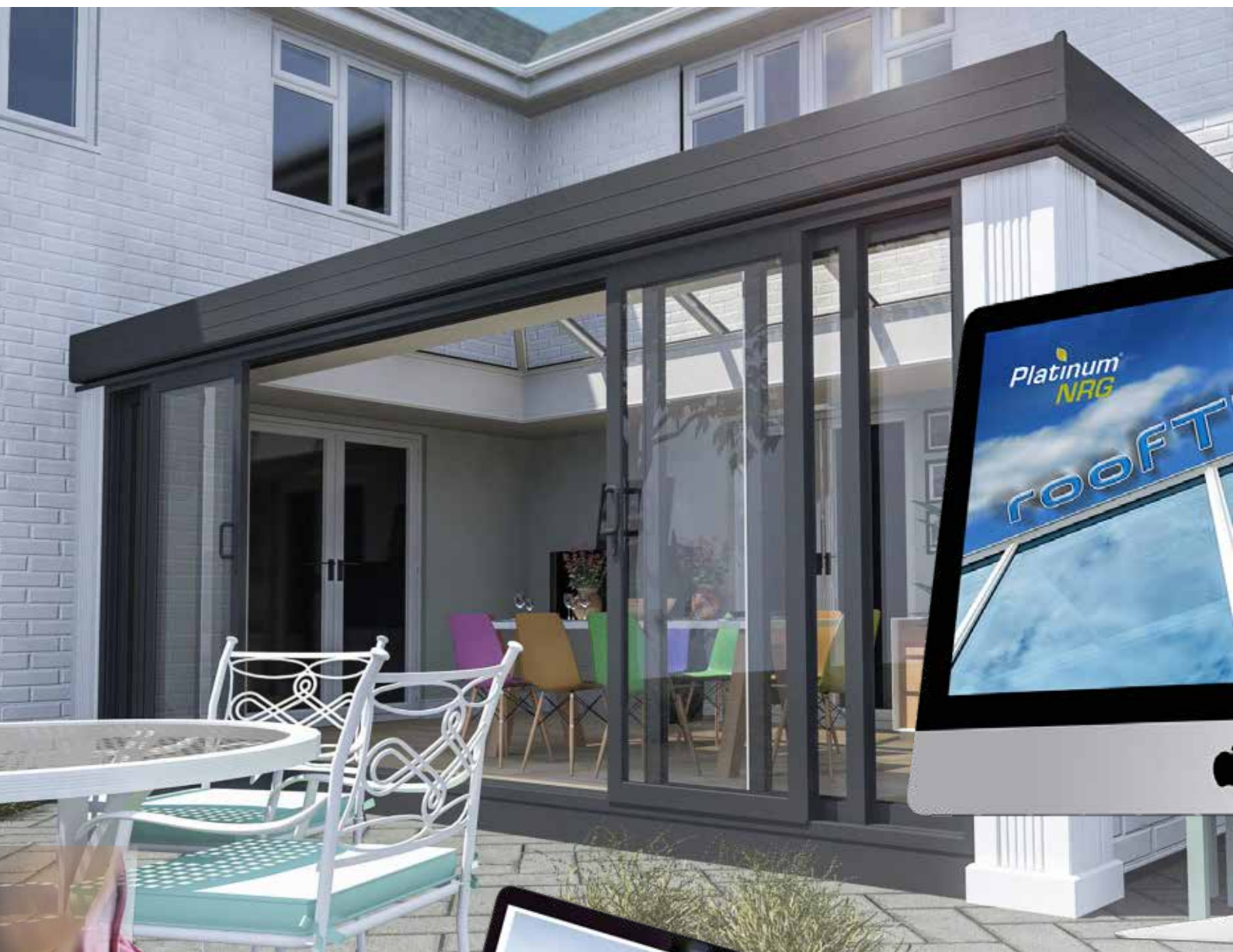

Every element of the conservatory can be priced in the same way that you would build the real thing. The intelligent pricing module takes in everything - from site preparation, ground-works and external drainage, building works, the frames and roof, and finally electrics, plumbing, carpentry and fitting.

## PC-based conservatory visualisation tool

roofTEK conservatory design software allows the conservatory sales team to 'build the dream' for their customers. Within a few minutes a full colour photo-realistic image of the conservatory, pulled from a wide library of different designs, can be displayed on the screen, with the customers' choice of frames, roof glass, brickwork, flooring and more.



The conservatory can be rotated on the screen, and can be superimposed easily onto a photograph of the clients' property.

Additional modules allow the roof, frames, ground works, building work, electrics and plumbing to be priced quickly and accurately and a range of attractive, professional presentations, quotations and contracts can be printed.

Our 3D design software offers a comprehensive range of styles, glazing, colour and roofing choices. Supplementary modules can be purchased as 'add on' options to include Bespoke Design, traditional Orangeries, Livin Room\* or Summer Orangery\* style internal pelmet and external fascia/decorative gutter, Tiled Roofs, Loggia\*, Pilaster and Veranda\*.

\* These names are trademarks of Ultraframe and Global roofs and are used to describe the styles of roof only. We are able to model any roof section accurately and in full 3D



# customer website

status, accounts, deliveries - all in one place

Home Orders **Financials** Deliveries Bulk Printing Confirmations Support Resources Rewards Settings

**Customer Account Summary for**  
As at 08/10/2020 10:01

[Print Statement](#) [Remittance Advice](#)

Balance	Current	30 Day	60 Day	90 Day	Unallocated	Disputed	unbanked	Promised	Overdue	Terms	Limit
£-7906.16	£0.00	£0.00	£0.00	£107.82	£-8,013.98	£0.00	£0.00	£0.00	£0.00	Prepaid	£0.00

Date	Type	Reference No	Customer Ref	Goods	VAT	Balance	Disputed	Overdue
02/04/19	Invoice		Ken Ray	£3,154.60	£630.92	£107.82		*
02/09/20	Payment	TRANS	11435	£-8,013.98	£0.00	£-8,013.98		*
<b>Totals:</b>				<b>£-4,859.38</b>	<b>£630.92</b>	<b>£-7,906.16</b>	<b>£0.00</b>	



Our customer website is your interface with our order status, accounting and delivery service.

Monitor your orders, order confirmations and delivery status in just a few clicks.

Home Orders Financials **Deliveries** Bulk Printing Confirmations

Select delivery Date:

Print one delivery note per job?

[Print](#)

Page: 1 of 3

**Delivery Note**

 Customer: Whiteline Group Ltd  
Telephone: 01323 723724  
Delivery Date: Tuesday 13/10/2020  
Printed on: Thursday 08/10/2020 at 10:04

Job No	Item Type	Description	Image	Loc'n	Check
X018987L	Frame 1	3410 x 2200 White - Chamf Window			[ ]
GOODS IN - YARD OFFICE					

# Window Designs Online

your online brochure and website builder



Services



**Window Designs Online (WDO) is a revolutionary compiler that enables a customer to build not only their own, bespoke printed brochure but also generate a dynamic, personalised website with built-in SEO.**

Using pages from our extensive literature library, a customer can create an individual brochure that incorporates only the products they want to sell.

Combining a choice of covers and introductory text, logos, individual address and contact details to create an individual publication at a fraction of the cost of using a marketing company.



Services

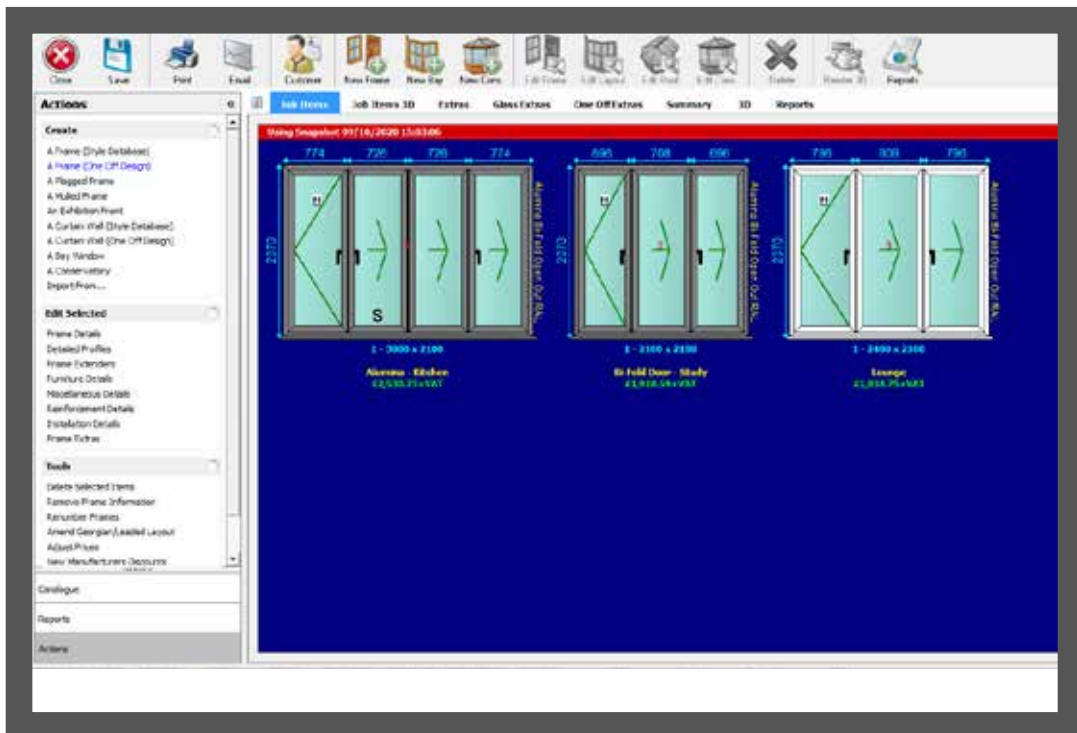
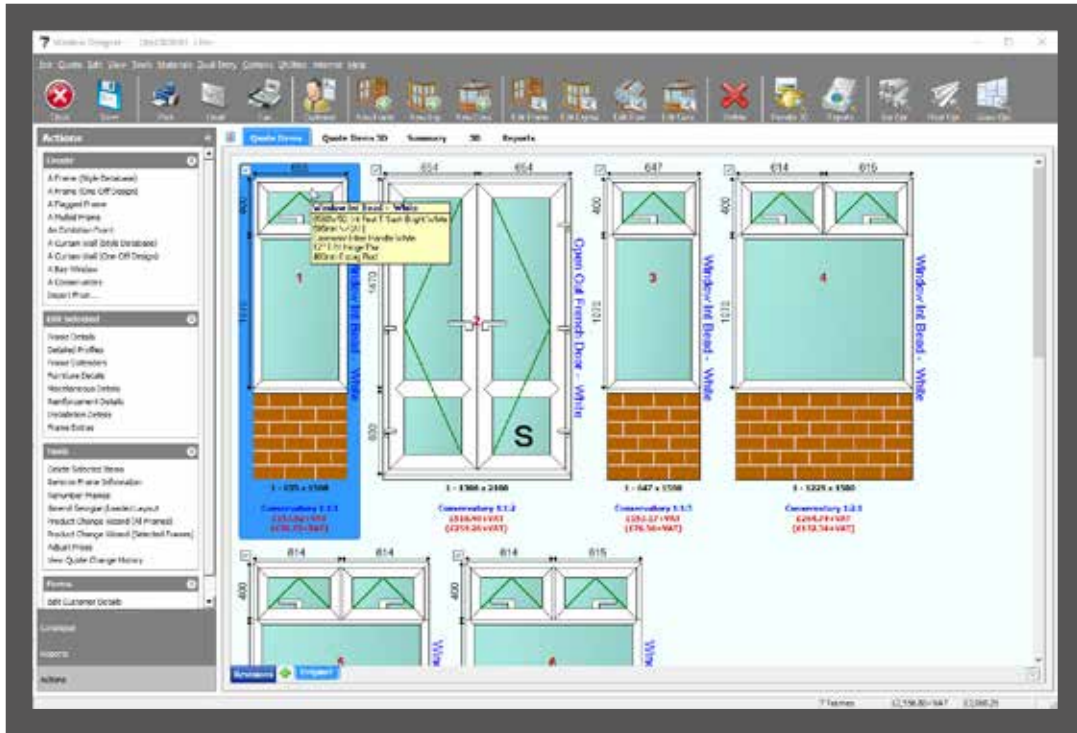

# Window Designer

your online quotation and job management package

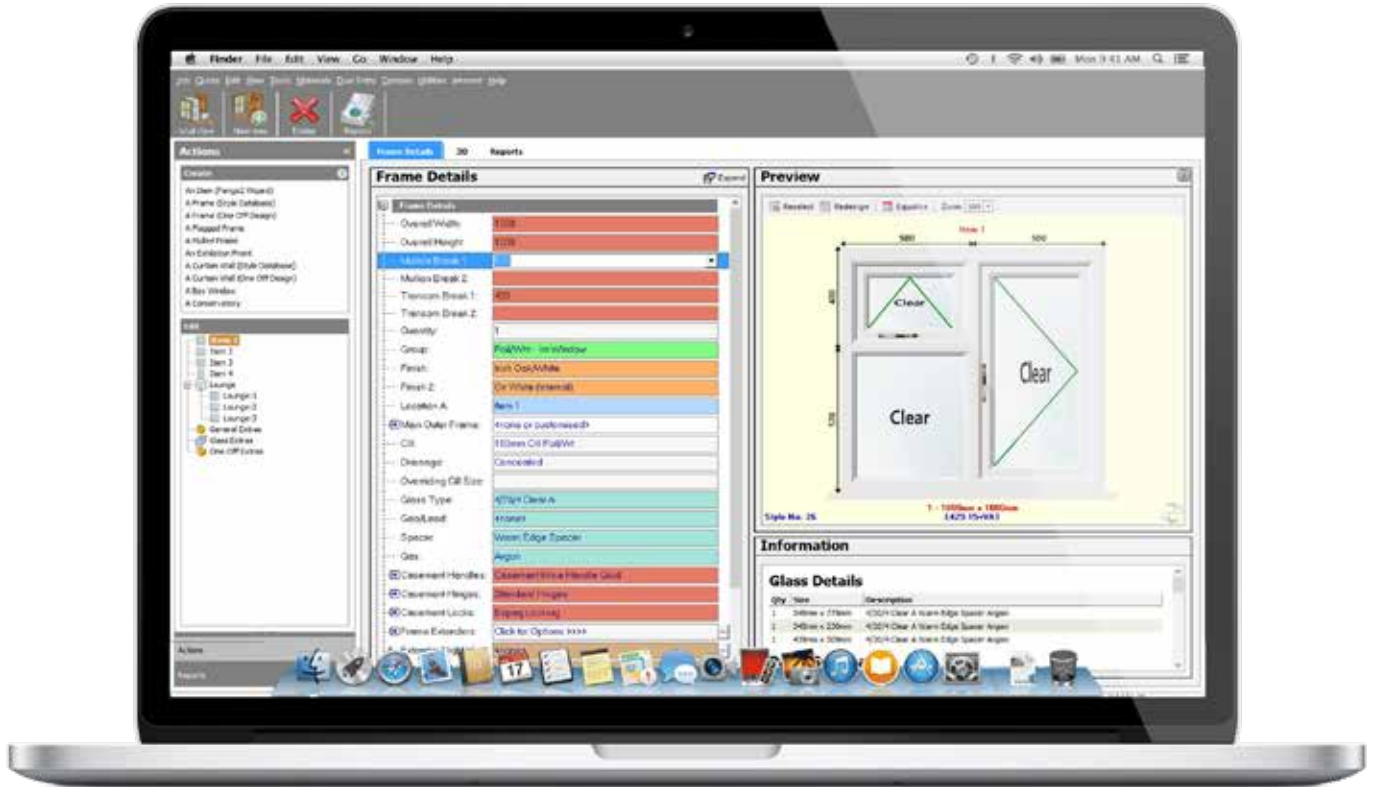

Services

**Window Designer** is accepted as the leading Fenestration software solution, and delivers cutting-edge functionality coupled with the required sales and manufacturing functionality demanded by today's fenestration industry.

**Window Designer** allows the design, pricing and manufacture of practically any style and shape of frame or door, including curved frames, composite doors and bi-folds. Whether it is trade, retail or commercial business, numerous pricing and multi-level discount structures can be implemented to cater for almost any situation.

## BEST CONFIGURATOR

**Window Designer** offers you the ability to configure frames in any way needed for manufacturing, all via an intuitive choice-based interface.

## MODERN REPORTING

**Window Designer** has the tools available for you to create professional, modern reporting to make your business stand out from the rest.

## FULLY CONFIGURABLE

Unlike other solutions in the marketplace, **Window Designer** is open for configuration. If you need to make a change to a material list, you can





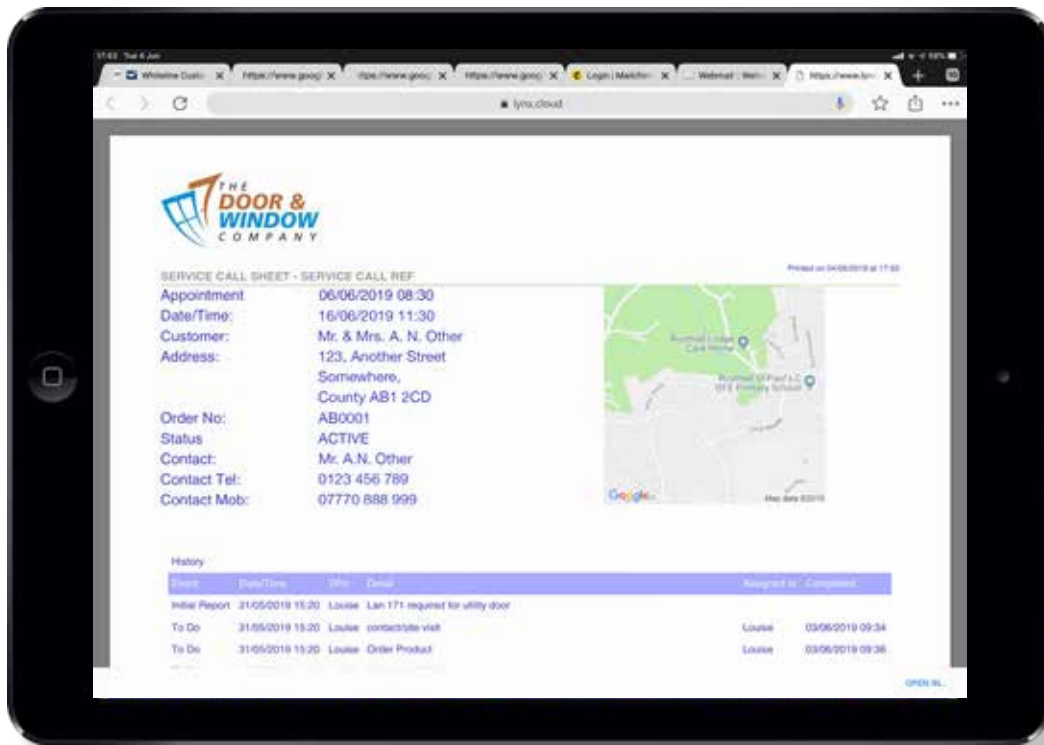

Services

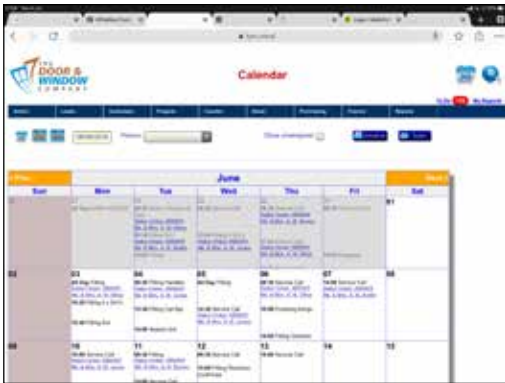

### OPERATING

Track all your customer information and interactions in one place and on any device. Nurture and monitor sales leads until they're ready for selling.

### MANAGING

Monitor work-flow to make the best use of your time and those around you. Keep everyone up-to-date, any time and from any where.

### COPING

Don't miss a customer response, a manufacturer's update or a changed delivery. Working remotely, you can get an overview of your existing and past sales meaning you can be prepared for the future.

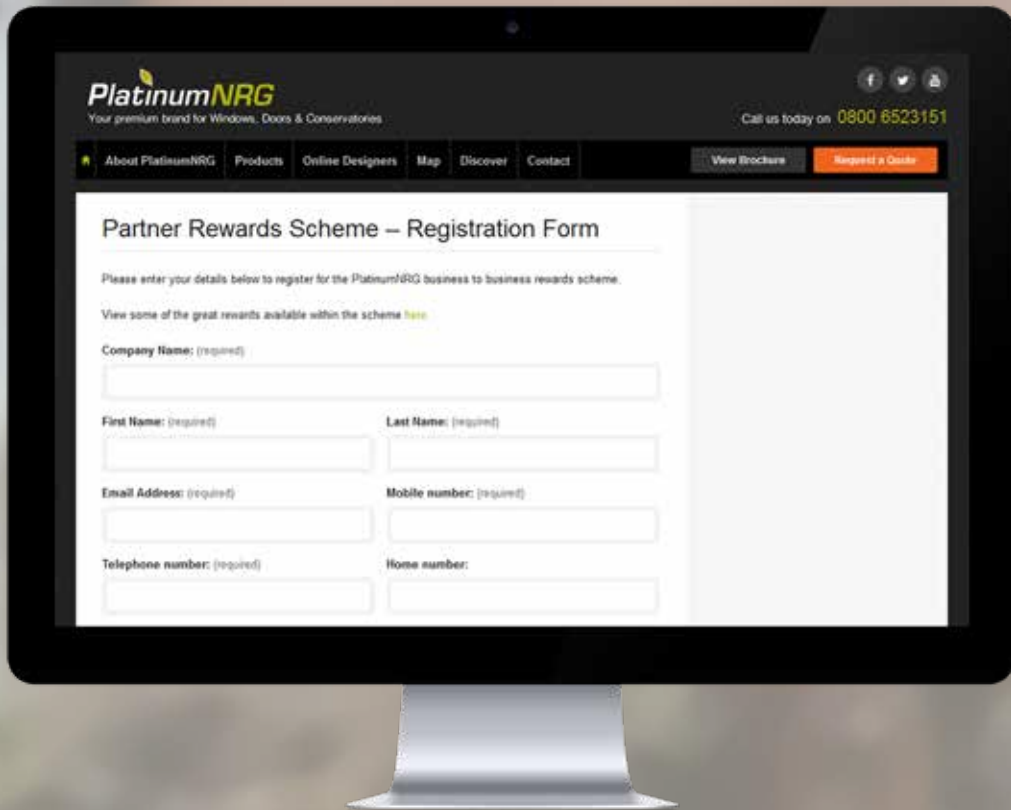

# rewards scheme

## sales staff incentive



### WHAT IT DOES

The Rewards Scheme is designed to incentivise and reward a company's staff who are responsible for sales. Every qualifying sale of PlatinumNRG products earn Reward Points.

These points are based on the total order value, which can then be collected and saved.

These points can then be converted into rewards - ranging from Store Vouchers to domestic appliances and entertainment.

### HOW

Each nominated staff member will need to register their personal details to join the scheme.

Once registered, each staff member will appear in the Whiteline Customer Area.

They will receive an email with their login credentials.

# accreditations



**BM TRADA** Product Certification provides assurance to specifiers, contractors and purchasers that products will perform to an agreed standard. It provides independent certification, testing and inspection, training and technical services all over the world.

All PlatinumNRG products are covered by the BM Trada Certification scheme.



The **UKCA** (UK Conformity Assessed) marking is a new UK product marking that will be used for goods being placed on the market in Great Britain (England, Wales and Scotland). It covers most goods which previously required the CE marking.



PlatinumNRG is proud to be a member of the **British Fenestration Rating Council**, the UK's national system for rating Energy Efficient Windows



**FENSA** (Fenestration Self-Assessment Scheme). Following Government encouragement, FENSA has been set up by the Glass and Glazing Federation (GGF) and other industry bodies, in response to Building Regulations for double glazing companies in England and Wales. When replacing windows and doors, homeowners must comply with current standards and ensure they obtain a certificate from FENSA (or similar approved) or Local Authority Building Control.



PlatinumNRG double-glazed PVCu casement windows can achieve the 'greenest' **Window Energy Ratings (WER)** rating of A+ for energy efficiency, if specified.



This is the official UK Police flagship initiative supporting the principles of 'designing out crime'. PlatinumNRG are very proud to have gained the **Secured by Design** accreditation for our products.

# certification

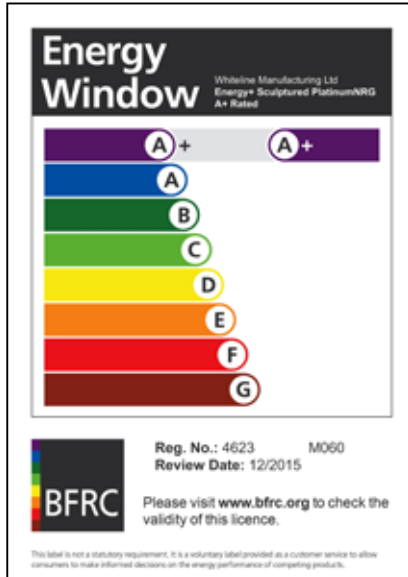

The **Window Energy Ratings** scheme was launched in the UK by the BFRF, a Government supported independent body which allows consumers to reliably compare one product with another.

The majority of our windows achieve an A-rating for energy efficiency and incorporate the very latest glazing technology using clear energy glass. UK homes create a quarter of the country's CO2 emissions.

By offering up to 3 times more thermal insulation than standard double glazing, our windows help eliminate energy loss from your home and are 20% better than Low-E thermally insulating glass.

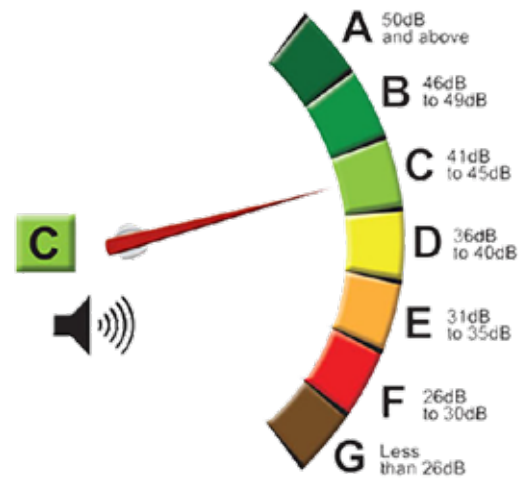

Our windows were the first in the UK to achieve the **BM TRADA Window Acoustic Rating** label. We can offer windows in a number of decibel ratings to help in the reduction of sound.



Established in 1984, we are one of the largest producers of windows, doors and conservatories in the South East of England so you can feel secure in the knowledge that we will be around for many more years to come, supporting you via our network of installation partners.

Your guarantee as part of your contract of sale will always be with your installation provider. However, it is reassuring to know that the PlatinumNRG range of products are also covered by a comprehensive set of guarantees from us to our installation partners.







CHAMFERED **SASH**

SCULPTURED **SASH**

FLUSH **SASH**

slim **SASH**

**aluminium**

**ColourTEK**

**FORTREZZ**  
SOLID TIMBER CORE DOORS



**t:** 0800 652 3151 **e:** [info@whiteline.co.uk](mailto:info@whiteline.co.uk) **w:** [www.whiteline.co.uk](http://www.whiteline.co.uk)



**BR0030 Platinum NRG Portfolio Brochure 1st Edition 2021**

All rights reserved © 2021 Platinum NRG

In our ongoing quest to provide the highest quality products our designs and specifications are subject to change without any notice. Except as allowed by law, no part of this publication may be reproduced in any form without written consent.

